

# Sabelt®

**CINTURE HARNESSES**



**RACING**



**KART**



**TUNING**



**SPORTSWEAR**



# CINTURE HARNESSSES

## INDICE INDEX

p. 4	<b>LABORATORIO PROVE</b> <i>TEST LABORATORY</i>
p. 5	<b>TEST DINAMICO</b> <i>DYNAMIC TEST</i>
p. 6	<b>FIBBIA A ROTAZIONE</b> <i>ROTARY BUCKLE</i>
p. 7	<b>LEGGEREZZA PRODOTTO-REGOLATORI</b> <i>PRODUCT LIGHTNESS-ADJUSTERS</i>
p. 8	<b>USO DELLE CINTURE CON HANS®</b> <i>USE OF HARNESSSES WITH HANS® DEVICE</i>
p. 10	<b>PUNTI DI ANCORAGGIO</b> <i>FIXING POINTS</i>
p. 12	<b>CINTURE TOP FORMULA</b> <i>TOP FORMULA HARNESSSES</i>
p. 12	<b>CINTURE PER MONOPOSTO</b> <i>SINGLE SEATER HARNESSSES</i>
p. 17	<b>CINTURE 6 PUNTI</b> <i>6 POINTS HARNESSSES</i>
p. 21	<b>CINTURE SFI</b> <i>SFI HARNESSSES</i>
p. 24	<b>CINTURE 4 PUNTI</b> <i>4 POINTS HARNESSSES</i>
p. 29	<b>MISURE CINTURE</b> <i>HARNESSSES MEASUREMENTS</i>
p. 30	<b>ACCESSORI</b> <i>ACCESSORIES</i>
p. 32	<b>CINTURE CLUBMAN</b> <i>CLUBMAN HARNESSSES</i>
p. 33	<b>CINTURE 4 PUNTI</b> <i>4 POINTS HARNESSSES</i>
p. 37	<b>CINTURE 3 PUNTI</b> <i>3 POINTS HARNESSSES</i>
p. 39	<b>COPRISPALLA 2"</b> <i>2" PADS</i>



# LABORATORIO PROVE

## TEST LABORATORY



### Misura del carico di rottura componenti.

Fibbie, nastri, regolatori, attacchi e cuciture sono sollecitati da un carico assiale, applicato ad una velocità di 100mm/1' (in accordo con lo Standard Fia 8853-54/98) fino alla loro rottura o fino ad un determinato valore al quale devono resistere senza deformazioni.

#### *Components breaking load measure.*

*Buckles, webbings, adjusters, brackets and seams are stressed with an axial load applied at 100mm/1' speed (according to FIA 8853-54/98 regulation) until their breaking or up to a fixed value they should resist without deforming.*

### Misura del microscorrimento dei nastri nei regolatori.

Il regolatore subisce 1000 cicli di sollevamenti e abbassamenti con un peso di 5 daN agganciato (par. 7.3.1 Standard Fia 8853-54/98). Al termine della prova lo scorrimento del nastro non deve essere superiore ai 25mm.

#### *Measurement of webbing micro slip in adjusters.*

*The adjuster is subjected to 1000 cycles of lifting and lowering with a 5 daN weight hooked on it (par. 7.3.1 8853-54/98 FIA regulation). At the end of the test, webbing slip should not be higher than 25mm.*



### Resistenza della fibbia al carico obliquo.

Il ramo addominale della cintura è sottoposto ad un carico di 24 kN (par. 6.2.4.5 Standard Fia 8853-54/98) applicato ad una velocità di 100mm/1'. Al termine della prova non ci devono essere rotture e la stessa fibbia viene successivamente sottoposta alla prova di apertura sotto carico.

#### *Buckle resistance to oblique load.*

*Harness Lap strap is subjected to 24kN load (par 6.2.4.5 of 8853-54/98 FIA Regulation) applied at 100mm/1' speed. At the end of this test there must be no breakings and the same buckle will be tested for the opening under preloaded load.*

### Misura della coppia di apertura della fibbia sotto carico.

La fibbia viene prima sottoposta ad un test dinamico o ad un carico obliquo e poi viene aperta dopo essere stata precaricata con 60daN, applicati alle lingue della fibbia. (par. 7.2.4 Standard Fia 8853-54/98). La coppia necessaria per avere l'apertura viene misurata ed il suo valore deve essere compreso tra 1 e 3,5 Nm.

#### *Measurement of Buckle opening torque under load.*

*After having been subjected to a dynamic or oblique load test the buckle is opened while loaded with 60daN applied to the tongues (par. 7.2.4 8853-54/98 FIA regulation). The torque necessary to open is measured and its value shall be within 1 and 3,5 Nm.*



### Resistenza delle parti metalliche alla corrosione (test in nebbia salina).

Tutte le parti metalliche che compongono la cintura devono resistere alla corrosione provocata dall'esposizione per 50 ore ad una miscela di acqua e cloruro di sodio opportunamente nebulizzata.

#### *Metallic parts resistance to corrosion (salt spray test).*

*Every metallic part of the harness must resist to corrosion caused by 50 hours exposure to a nebulized mixture of water and sodium chloride.*



# TEST DINAMICO

## DYNAMIC TEST

Questa prova, prescritta dai Regolamenti ECE (europeo) e Fia, serve a verificare la resistenza e l'efficacia delle cinture da competizione.

L'apparecchio consiste in un carrello che, muovendosi lungo una rotaia, viene lanciato con un sistema di elastici contro una barriera fissa. Il carrello simula evidentemente l'automobile e questo impatto dovrebbe rappresentare quello che succede in un incidente di grave severità.

La cintura viene indossata da un manichino seduto sul carrello di prova (foto 1), che viene lanciato ad una velocità di 50km/h e bruscamente frenato (foto 2) in modo da simulare un urto estremamente severo. Il manichino utilizzato è il TN10, la frenata è realizzata mediante il contatto tra tubi di poliuretano e ogive di acciaio (foto 4). I sedili di prova sono di due tipi, quello più verticale per cinture a 3-4 punti di ancoraggio e quello più orizzontale per cinture a 5-6 punti di ancoraggio. Un sistema elettronico acquisisce ed elabora i dati provenienti dall'accelerometro posto sul carrello di prova e fornisce il diagramma della decelerazione subita nel dato intervallo di tempo (foto 3).

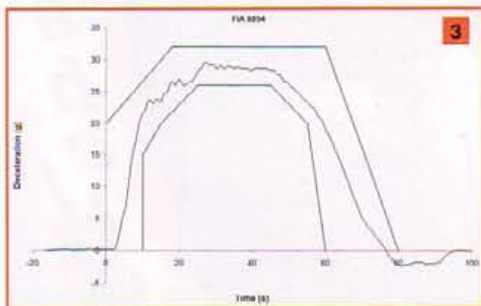

*This test, required by ECE and FIA norms verifies the strength and effectiveness of competition harnesses.*

*The dynamic test consists of a trolley that, moving on a rail, is launched against a fixed barrier, thus simulating the car involved in a serious crash.*

*The harness on TN10 one leg dummy seated on the test trolley (picture 1) which is launched by means of elastic bands at 50km/h speed against the fixed barrier (picture 2).*

*The stopping is obtained through the contact between polyurethane tubes and steel ogives (picture 4).*

*Two kind of seats are used in dynamic tests: vertical seat to test 3-4 points harnesses and horizontal one for the 5-6 points models.*

*An electronic system logs and processes the data from the accelerometer situated on the test trolley and provides the diagram related to deceleration vs time (picture 3).*

# FIBBIA A ROTAZIONE

## ROTARY BUCKLE

Le cinture da competizione Sabelt impiegano una fibbia a sgancio rapido a rotazione realizzata con componenti in lega di alluminio pressofusa, acciaio e, nelle versioni ultraleggera, titanio; il meccanismo (foto 1), collaudato da trent'anni di utilizzo da parte di piloti professionisti, si contraddistingue per le seguenti caratteristiche:

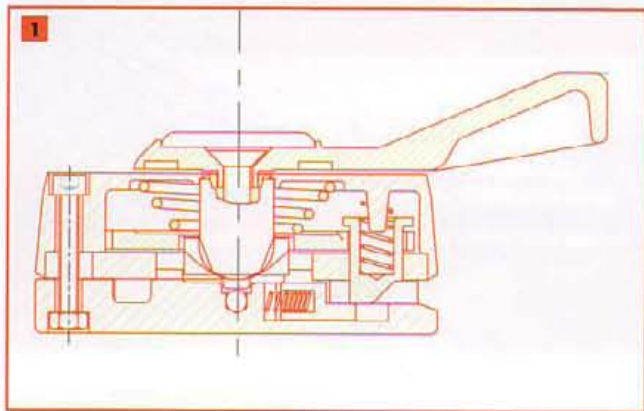

- posizioni della leva in apertura e chiusura nette e distinte;
- leva con conformazione tale da consentire l'operazione di apertura in maniera agevole anche in situazioni di emergenza;
- assenza di parti plastiche nel meccanismo di apertura;
- resistenza a trazione statica superiore del 40% al valore prescritto dallo Standard Fia 8853-54/98.

La versione ultraleggera con minileva rivolta verso l'alto (foto 2), più volte campione del mondo di Formula 1, ha un peso di soli 170 grammi.

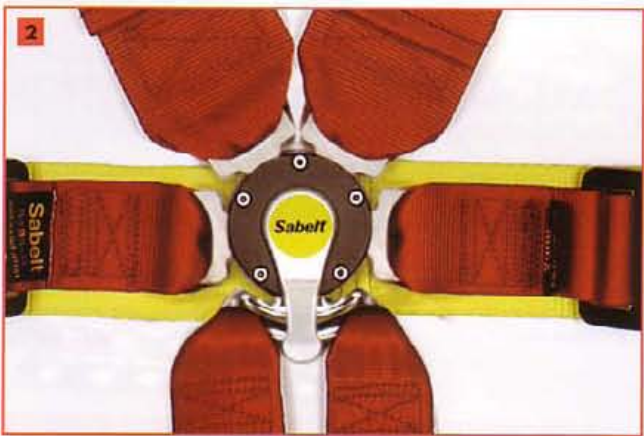

La versione con minileva e riparo proteggi leva (foto 3), sviluppata in collaborazione con J.P. Montoya, ha le caratteristiche di avere una protezione inferiore e una leva con profilo poco prominente atte a preservare la leva stessa dal contatto accidentale con le gambe o con le braccia del pilota. Per queste sue caratteristiche è oggetto di brevetti Epo, Usa e Giappone.



*In Sabelt competition harnesses we use rotary quick release buckles made with die-casted aluminium alloy components, steel and titanium in the ultra light versions.*

*Buckle mechanism (picture 1), tested by the World top drivers over the last 30 years, has the following characteristics:*

- opening/closing lever positions are clear and distinct;
- lever structure to allow easy opening operation even in emergency situations;
- absence of plastic parts in opening mechanism;
- static traction resistance 40% higher than FIA standard 8853-54/98 requirement.

*The ultra light version with upwards bent mini lever (picture n 2), several times F1 World champion, weights only 170 grams.*

*The mini lever version with lever protection cover (picture n3), developed together with J.P. Montoya, thanks to its lower protection and small profile lever shape, avoids the accidental contact with driver legs or arms.*

*Epo, USA and Japan patented.*



# LEGGEREZZA PRODOTTO

## PRODUCT LIGHTNESS

Le cinture Sabelt si distinguono per l'estrema leggerezza a fronte di eccezionali caratteristiche di resistenza meccanica. Anni di ricerca e sviluppo hanno consentito di ottenere un alleggerimento della cintura da competizione sino a raggiungere, nel caso dei modelli utilizzati in F1, un peso totale di appena 800 gr. Uno dei materiali che consentono di ottenere elevate riduzioni di peso è il titanio, che - nel livello di purezza gr. 5 (quello utilizzato da Sabelt e derivato dall'industria aeronautica) - ha un peso specifico pari al 58% dell'acciaio e caratteristiche meccaniche nettamente superiori.

Con il titanio vengono realizzati i principali componenti delle cinture extra-light (foto 1,2,3,4). Insieme al titanio, Sabelt utilizza per i propri componenti anche l'alluminio, che - grazie ad un peso specifico pari al 27% dell'acciaio e a caratteristiche di ottima lavorabilità - ha trovato impiego nei componenti delle fibbie e dei regolatori.

Anche mediante l'acciaio al carbonio trattato termicamente è stata ottenuta una sensibile riduzione di peso, grazie all'ingegnerizzazione di componenti dalle dimensioni estremamente contenute e dall'ottima funzionalità, come le minilingue presenti su tutte le cinture top formula, i nuovi T-bar anatomici (foto 5), i regolatori Steel Pro. Sempre in acciaio vengono realizzati componenti speciali come i moschettoni "carabiner" (foto 6) utilizzati in alcune specifiche applicazioni.

Il particolare nastro in poliestere è un ulteriore punto di forza delle cinture Sabelt; ottenuto grazie ad una scrupolosa scelta dei filati e ad un perfezionato numero di fili e costruzione di trama e ordito, esso ha consentito di raggiungere un peso di soli 85 gr/m. (nella versione 3" di larghezza) con caratteristiche

di resistenza meccanica superiori del 70% al valore prescritto dallo Standard Fia 8853-54/98 e con un'altissima resistenza all'abrasione.

*The outstanding lightness, combined with extraordinary mechanical resistance, characterizes all Sabelt harnesses. Years of research and development enabled Sabelt to reduce competition harnesses weight and reach, in case of some F1 models, a total weight of 800 gr.*

*One of the materials which made this weight reduction possible is titanium. The 5 gr purity level used by Sabelt (and derived from the aeronautical industry) weighs 58% compared to steel but has much higher mechanical characteristics.*

*Most of the components of the ultra-light harnesses are made of titanium (picture 1,2,3,4). Besides that, Sabelt is also using aluminium, which weighs 27% compared to steel and thanks to its workability is the best choice for buckle and adjuster components.*

*Thanks to the engineering of extra-small size components such as the mini-tangs, new anatomical T-bars (picture 5) and Steel Pro adjusters, an important weight reduction has been achieved with steel, too. Steel is also used for other specific applications, such as the "carabiner" hooks (picture 6).*

*Another important plus of Sabelt harnesses is the special polyester webbing, obtained through a premium choice of threads as well through to the special construction of warp and weft and the number of yarns. With a weight of just 85 gr/m. (in the 3" width), it has mechanical properties 70% higher than Fia Standard 8853-54/98 requirements and extremely high resistance to abrasion.*



# REGOLATORI

## ADJUSTERS

### Versione in alluminio per nastro 3" (foto 1):

è realizzato in lega di alluminio stampata a caldo ed è provvisto di una leva (anch'essa in lega di alluminio) per l'allentamento rapido della cintura. Pesa circa 100 grammi ed ha un valore di resistenza a trazione statica superiore del 100% al valore prescritto dallo Standard Fia 8853-54/98.

### Aluminium adjuster for 3" webbing (picture 1):

*it is made in hot pressed aluminium alloy and it has a lever (in aluminium) for the quick harness release. It weighs around 100 gr. and its static traction resistance reading is 100% higher than FIA 8853-54/98 requirements.*

### Versione in acciaio + alluminio per nastro 3" (foto 2):

è realizzato con corpo in acciaio stampato e barretta pivotante in estruso di lega di alluminio. Pesa circa 90 grammi e si caratterizza per la forma particolarmente arrotondata e per la sua ridotta larghezza, che ne rendono minima la protrusione dal nastro, in modo da ridurre al minimo il contatto con il corpo del pilota. Anch'esso ha un valore di resistenza a trazione statica largamente superiore al valore prescritto dallo Standard Fia 8853-54/98.

### Steel+ aluminium adjuster for 3" webbing (picture 2):

*steel body with pivoting bar in extruded aluminium alloy. It weighs around 90gr. and is characterized by the smooth rounded shape and by reduced width, thanks to which its protrusion is minimum, to make the contact with driver's body imperceptible. Also this adjuster has a static traction resistance reading considerably higher than FIA 8853-54/98 requirements.*

### Versione in acciaio per nastro 2" (foto 3):

è realizzato con corpo e barretta in acciaio ed è provvisto di un carter plastico di contenimento delle parti. Pesa circa 60 grammi ed ha un valore di resistenza a trazione statica superiore del 100% al valore prescritto dallo Standard Fia 8853-54/98.

### Steel Version for 2" webbing (picture 3):

*body and bar in steel, it has a parts containment plastic carter. It weighs about 60gr. and its static traction resistance reading is 100% higher than FIA 8853-54/98 requirements.*



# CINTURE PER HANS® HARNESSSES FOR HANS®

Le attività di sviluppo delle cinture Sabelt svolte nell'ottica di un loro adattamento al collare Hans® e i risultati raggiunti hanno fatto sì che l'intera gamma di cinture Sabelt da 75mm sia stata riconosciuta come "Hans® Friendly" dalla Hubbard/Downing Inc. USA.

*Thanks to the good results of Sabelt development activities to make its harnesses suitable for use with Hans® device, the whole range of 3" Sabelt harnesses has been recognised as "Hans® Friendly" by Hubbard/Downing Inc. USA.*



Nel caso di utilizzo di collare Hans®, la Sabelt raccomanda di impiegare solo cinture a 6 punti di ancoraggio. Tutti i modelli a 6 punti della gamma Sabelt sono compatibili con il collare Hans®.

Per un corretto uso della cintura con l'Hans®, il regolatore della bretella dovrebbe essere posizionato sul giogo del collare in modo tale che il suo bordo superiore stia a non più di 70mm dal bordo inferiore del giogo stesso, come indicato nella figura 1.

*When using Hans® Device, Sabelt recommends 6 points harnesses.*

*The whole range of Sabelt 6 points harnesses is Hans® compatible.*

*For a correct use of the harnesses with Hans® device, the shoulder straps adjuster shall be positioned on the Hans® yoke with the upper edge at a distance of no more than 70mm from the lower edge of the Hans® yoke. (picture 1)*

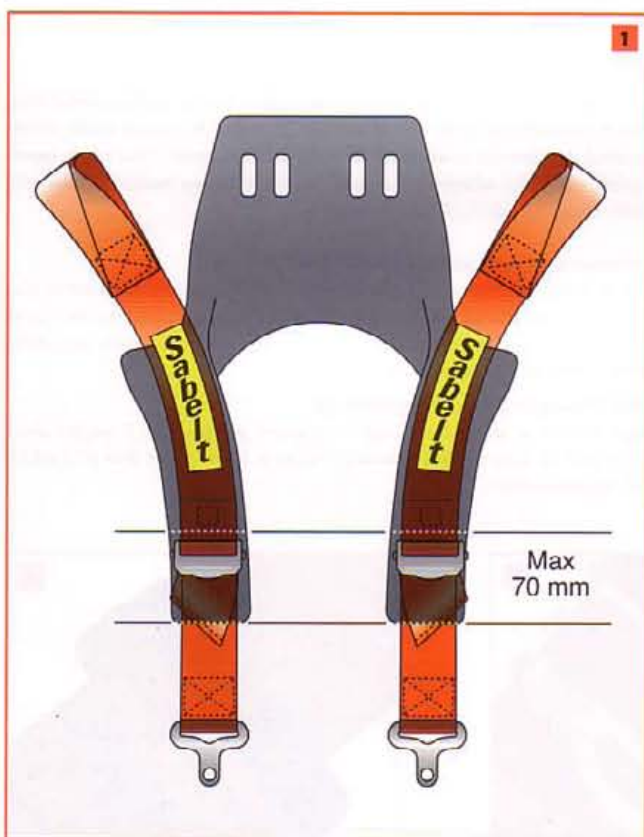

Al fine di evitare lo scivolamento laterale delle bretelle si raccomanda che i punti di fissaggio delle bretelle sulla vettura siano simmetrici rispetto all'asse centrale del sedile.

Guardando le cinture dall'alto l'angolazione delle bretelle deve essere di circa 20°-25°, come indicato nella figura 2, eventualmente anche incrociando le bretelle.

*In order to avoid shoulder belt lateral sliding, Sabelt recommends that fixing points on vehicle are symmetrical about the centre line of the driver's seat.*

*Viewing from above, the angle between the belts shall be about 20°-25° as shown in fig.2; if necessary it's possible to cross the belts.*

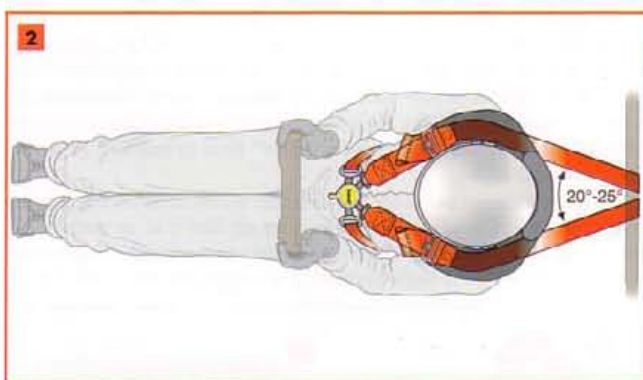

La parte posteriore delle bretelle deve tendere verso il basso tra gli 0° e i 20° partendo dal punto più alto di contatto con la superficie dell'Hans® fino al punto di fissaggio sulla vettura, come da fig.3

Indicazioni più dettagliate in funzione delle dimensioni del collare Hans® possono essere ricavate dalle istruzioni "guide for the use of Hans® in motorsport" emesse da FIA Institute - 01/12/2004

*The rear part of the shoulder strap should slope down by to 0° to 20° from the upperst point of contact with the Hans® device surface to the anchorage point on the car (fig.3)*

*For more details please see the FIA Institute instructions: "guide for the use of Hans® in Motorsport" issued on 01/12/2004.*

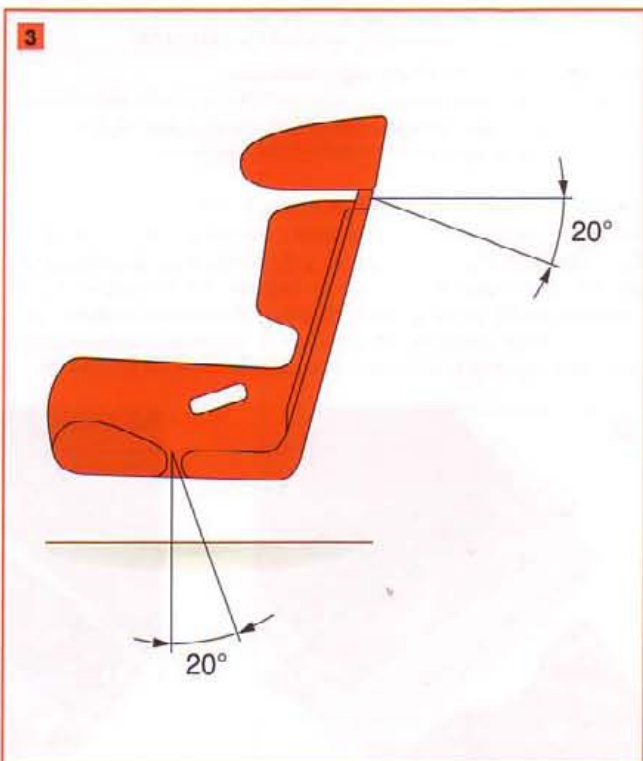

Al fine di ottimizzare in ogni circostanza l'interazione tra Hans®, cinture, attacchi vettura e pilota, Sabelt ha messo a punto due tipi di bretelle che possono comunque essere utilizzate solo in combinazione con l'Hans®.

*In order to optimize in any circumstance the interaction among Hans® device, harness, anchorage points on vehicle and the driver, Sabelt developed two different shoulder straps solutions that can be used, anyway, only in combination with the Hans® device.*



EH1: Versione con nastro da 50mm nella zona a contatto con il collare .

*EH1: 2" webbing in the section in contact with the Hans® device.*



EH2: Versione costituita da 2 nastri; uno da 75mm per il trattenimento del corpo, l'altro da 50mm specifico per trattenere il collare con sistema di regolazione indipendente.

Per maggiori dettagli sull'installazione, che deve comunque prevedere una seconda serie di ancoraggi su vettura, fare riferimento a quanto indicato nel "Guide for the use of Hans® in Motorsport".

*EH2: This version is composed by 2 webbings; a 3" one for body restraint and a 2" with its own regulation system for restraining Hans® device.*

*For further info regarding installation, for which double series of anchorage points is necessary, please see the "guide for the use of Hans® in Motorsport"*



Cuscinetto in gel da posizionare sotto l'Hans®. Comfort gel padding to put under Hans® device.

# PUNTI DI ANCORAGGIO

## FIXING POINTS

La posizione dei punti di ancoraggio delle cinture è stata determinata a seguito di intense attività di ricerca e sperimentazione ed ha fondamentale importanza sull'efficacia del sistema di ritenuta nel caso di incidente. L'introduzione del collare Hans® ha poi determinato dei nuovi criteri di definizione dei punti di ancoraggio delle cinture.

La Sabelt consiglia di utilizzare gli ancoraggi previsti dal costruttore del veicolo.

1. Ubicazione degli ancoraggi per vetture derivate dalla serie (fig.1-2)

- Ancoraggi (A-B) dei rami addominali: si trovano uno a destra, generalmente sul sedile, e uno a sinistra sul longherone vettura (per vetture guida sinistra)
- Ancoraggio (C) o ancoraggi (C-D) delle bretelle: si usano gli ancoraggi inferiori delle cinture posteriori (ubicati generalmente sotto i cuscini posteriori).
- In ogni caso consultare il libretto d'uso e manutenzione della vettura e reperire gli ancoraggi.

*As a result of intensive testing activities, the position of the fixing points has an imperative importance on the effectiveness of the restraint system in case of accident. The introduction of the Hans® device has determined new positioning of the fixing points.*

*Sabelt recommends to use anchorage points provided by the car manufacturer.*

1. Location of the anchorages in series derived cars (see 1-2)

- Anchorage (A-B) for lap straps: these are located one on the right, generally on the seat, and one on the left, on the car side member (in LHD cars)
- Anchorage (C) or anchorages (C-D) for the shoulder straps: use the lower anchorages of the rear seat belts (usually located under the rear cushions).
- See the car use & maintenance leaflet to locate the anchorages.

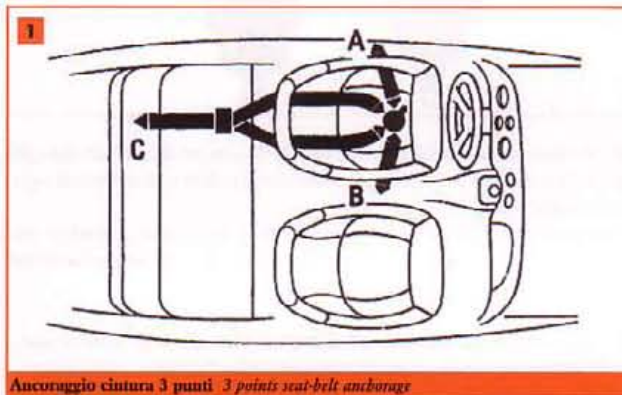

Ancoraggio cintura 3 punti - 3 points seat-belt anchorage

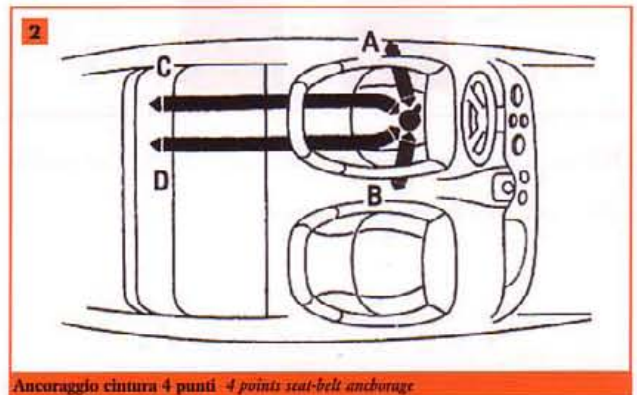

Ancoraggio cintura 4 punti - 4 points seat-belt anchorage

2. Fissaggio dei rami cintura ai relativi ancoraggi del veicolo.

A seconda del modello di cintura, ci sono vari tipi possibili di sistemi di fissaggio rappresentati ad esempio nelle figure 3-4-5-6-7-8-9.

Nel montaggio in fig.4 occorre verificare che a fissaggio avvenuto la staffetta "A" possa ruotare agevolmente intorno alla vite in modo da autoposizionarsi correttamente.

In ogni caso i sistemi di fissaggio dei vari modelli di cinture sono conformi agli standards FIA 8853/98 e 8854/98 o ECE 16/04.

2. Fastening the seat belt straps to the relevant anchorages in the car.

Depending on harness model, there may be different fastening systems as shown in pictures 3-4-5-6-7-8-9.

When assembling like picture 4, please make sure that the harness straps fastened with bracket "A" can freely rotate around the screw into correct position.

All fastening systems of the different models follow FIA 8853/98 and 8854/98 or ECE 16/04 regulations.

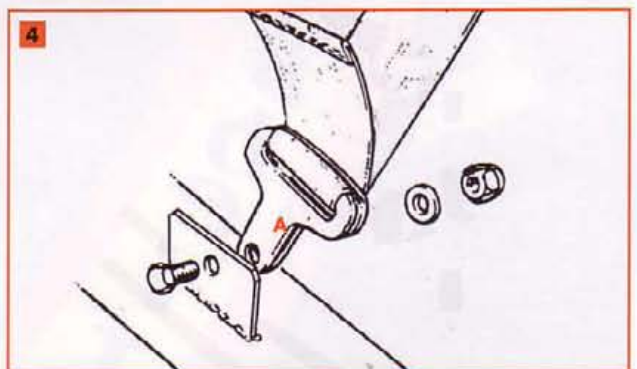
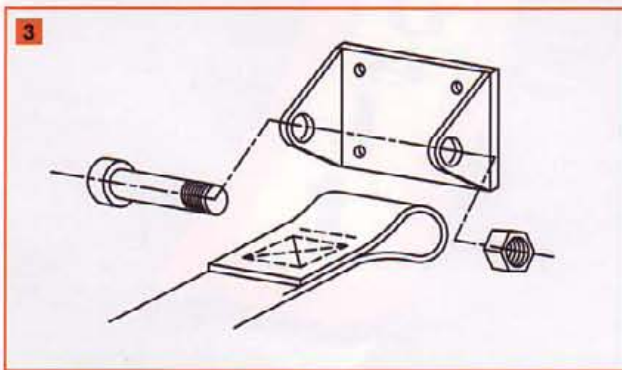

Esempio di attacco su piastra esistente in vettura  
Example of bolt fixing by using existing anchorage plate

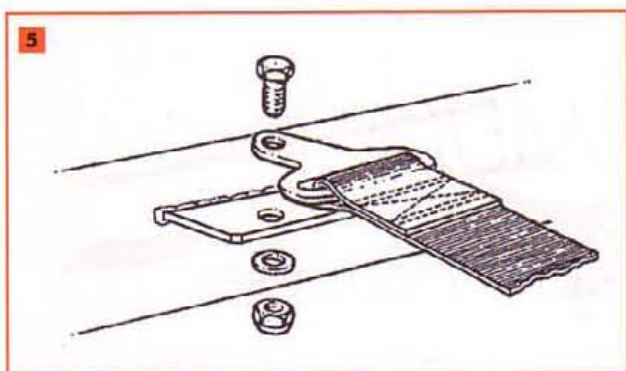

**5**  
Esempio di attacco su piastra esistente in vettura  
Example of bolt fixing by using existing anchorage plate

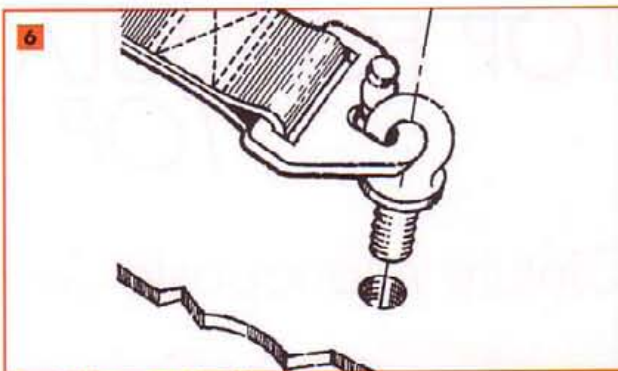

**6**  
Esempio di attacco con foro esistente in vettura  
Example of eye bolt fixing by using existing anchorage point

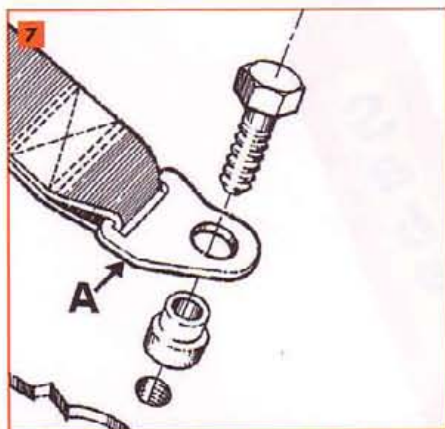

**7**  
Esempio di attacco su punto di ancoraggio esistente.  
La boccola permette la rotazione della staffa nella corretta posizione.  
Example of bolt fixing on existing anchorage point.  
The bush allows rotation of the bracket into the correct position.

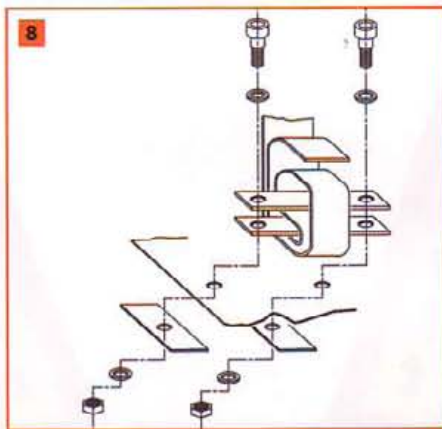

**8**  
Fissaggio del nastro libero tramite doppia piastra, su punto di ancoraggio con l'uso di piastra di rinforzo.  
Free ends straps fixed by mean of double plates, on anchorage point with use of reinforcement plate.

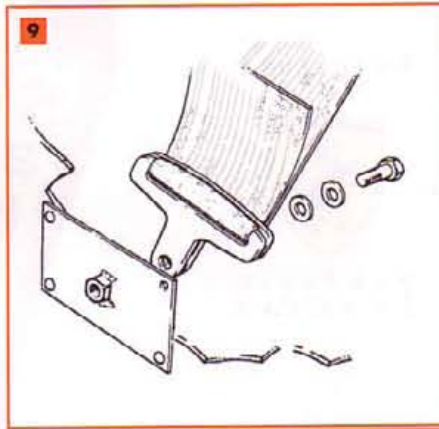

**9**  
Esempio di attacco su punto di ancoraggio non originale utilizzando una piastra di rinforzo FIA.  
Example of fixing on non-original anchorage points using a FIA reinforcement plate.

### 3. Fissaggio bretelle su roll-bar

Usare questo sistema di fissaggio seguendo le indicazioni delle fig. 10 e 11 e rispettando scrupolosamente le prescrizioni dell'Allegato J della FIA par. 6.2. Sabelt declina ogni responsabilità nel caso di roll-bar non conforme o di non corretto montaggio.

#### Esempio di fissaggio:

#### 3. Shoulder strap fixing to Roll-cage

When using wrap around, instructions in picture 10-11, strictly respect provisions of FIA Annex J-par. 6.2.

Sabelt declines any liability in case of erroneous assembly of harness and if roll cage is not complying with regulations in force.

#### Example of wrap around belt fixing

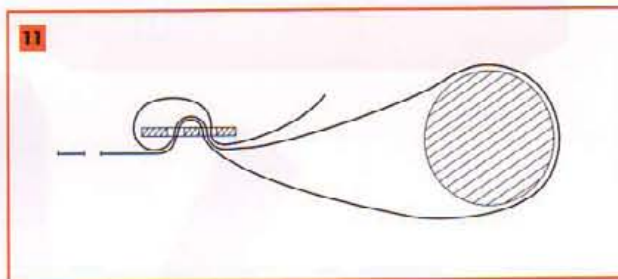
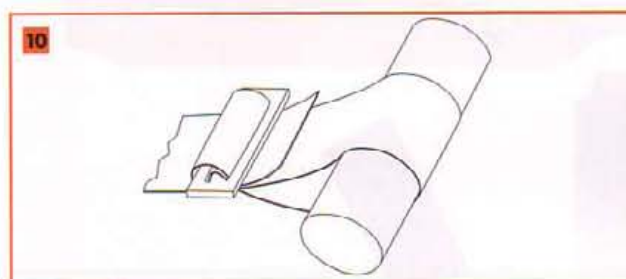

### 4. Importante

-Per il montaggio della cintura sulla vettura utilizzare solo i punti di ancoraggio previsti dalla casa costruttrice del veicolo.

-Nel caso che, per l'installazione di cinture omologate FIA, si rendesse necessaria la realizzazione di ulteriori punti di ancoraggio sulla scocca oltre a quelli di serie della vettura, questi dovranno essere comunque conformi a quanto prescritto dalle norme FIA in vigore alla data del montaggio (allegato J art. 253-42). In ogni caso le cinture installate dovranno rispettare gli angoli previsti dalle stesse norme FIA.

-Non forare, manomettere, smontare o asportare nessuna delle parti che compongono la cintura di sicurezza.

-La cintura di sicurezza in tutte le sue parti non deve sfregare e non deve essere a contatto con superfici acuminate o taglienti come lamiere o spigolo vivi.

-Durante il montaggio e l'uso evitare di sporcare la cintura di sicurezza con olio, grasso o sostanze che possano diminuire l'attrito delle cinghie in corrispondenza dei regolatori o intaccare il tessuto corrodendolo (es. smacchiatori o diluenti).

#### 4. Warning

To assemble the harness onto the car use only the anchorage points provided by the car manufacturer.

If you need to assemble the FIA homologated harnesses and need more anchorage points on the car body - other than the standard ones - these former must be in compliance with FIA regulations in force when installing. (annex J, art. 253-42)

Anyway, assembled harnesses angles must be in compliance with FIA regulations.

- Do not pierce, fiddle, disassemble or remove any of the harness parts.

-No harness parts shall rub against any surface or be in contact with rough or cutting surfaces such as plates or sharp edges.

-While mounting and using harnesses, avoid dirtying with oil, grease or substances that are likely to decrease its friction through the adjusters or damage harness webbing by corroding it (removers or solvents).

# TOP FORMULA

# TOP FORMULA

## Cinture Monoposto Single Seater Harnesses

Cintura Team Ferrari F1  
*The harness used by Ferrari F1.*

Fornitore



Seuderia  
 Ferrari

Regolatore in lega di alluminio.  
*Aluminium alloy adjuster.*

Fibbia Sabelt Ultralight. Mini-lingue  
 e baffo cosciale in titanio. Peso 170 gr.  
*Ultralight Sabelt buckle. Titanium mini-tangs  
 and T-bar. Weight: 170 gr.*

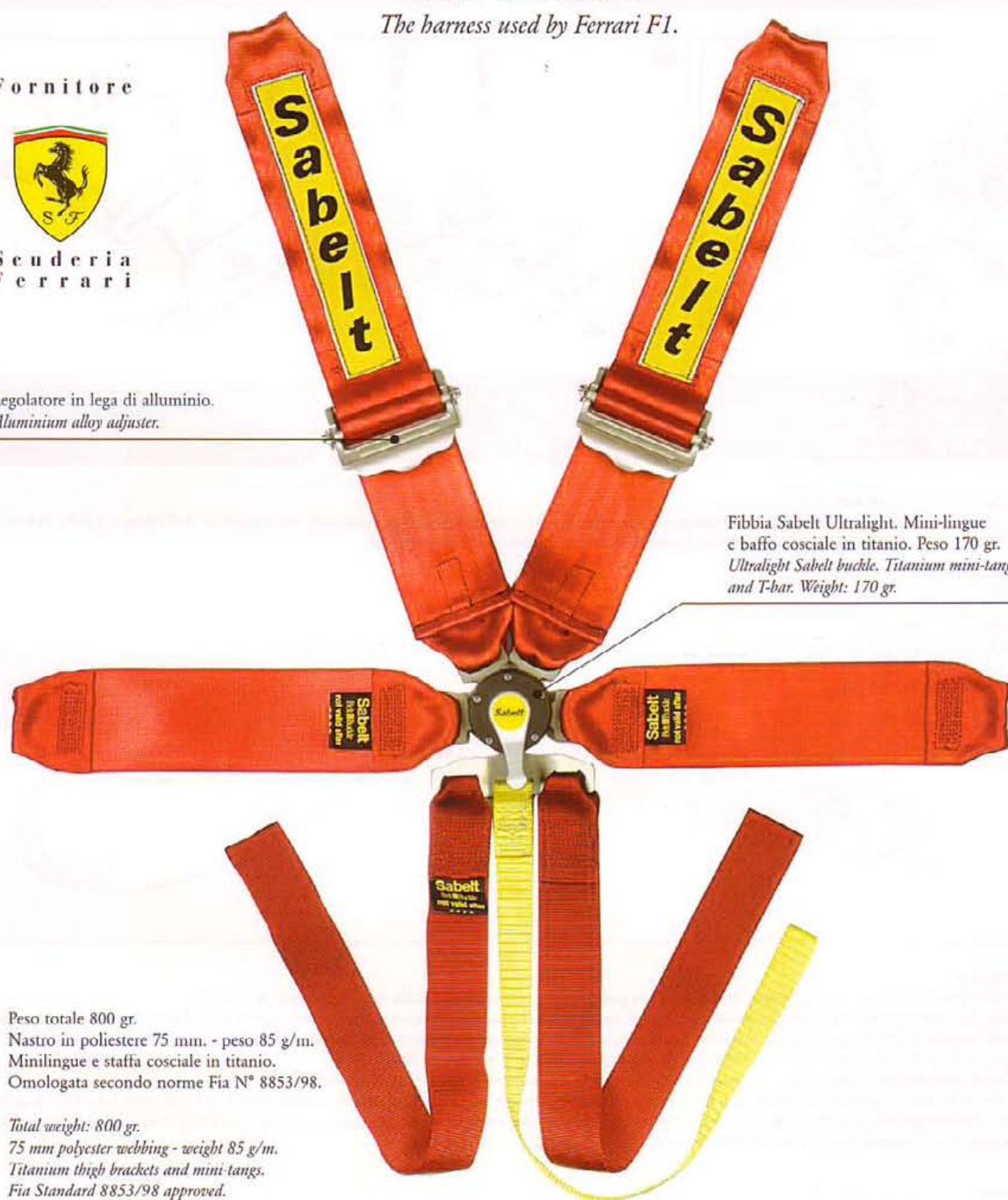

Peso totale 800 gr.  
 Nastro in poliestere 75 mm. - peso 85 g/m.  
 Minilingue e staffa cosciale in titanio.  
 Omologata secondo norme Fia N° 8853/98.

*Total weight: 800 gr.  
 75 mm polyester webbing - weight 85 g/m.  
 Titanium thigh brackets and mini-tangs.  
 Fia Standard 8853/98 approved.*

Le cinture Sabelt sono utilizzate in F1 dai team Ferrari, Williams, Red Bull e Toro Rosso.  
*In F1 Sabelt Harnesses have been chosen by Ferrari, Williams, Red Bull and Toro Rosso.*

**904604E** ROSSO/RED  
**902604E** NERO/BLACK  
**901604E** BLU/BLE  
**907604E** GRIGIO/GREY

Punti di ancoraggio: 6

Fissaggio bretelle: staffa con foro diametro 8.5mm.

Fissaggio addominali e cosciali: doppia staffa con regolazione lunghezza con foro diametro 8.1mm.

Regolatore professionale in alluminio.

Lingue allungate per alloggiare il loop.

Fibbia con mini-leva e guscio protettivo.

Nastro: 3"/3". Omologazione FIA 8853/98.

*Fixing points: 6*

*Shoulder strap fixing: 8.5mm diameter hole bracket.*

*Waist and crutch straps fixing: 8.1mm diameter hole double bracket for length adjustment.*

*Professional aluminium adjusters.*

*Longer tongue for loop housing.*

*Mini-lever and lever protection cover buckle.*

*Webbing: 3"/3". FIA Homologation: 8853/98*



**904** ROSSO/RED



**901** BLU/BLE



**902** NERO/BLACK



**907** GRIGIO/GREY



TUTTE LE CINTURE SONO DISPONIBILI IN QUATTRO DIVERSI COLORI  
 ALL HARNESES ARE AVAILABLE IN FOUR DIFFERENT COLOURS

**904605E** ROSSO/RED  
**902605E** NERO/BLACK  
**901605E** BLU/BLUE  
**907605E** GRIGIO/GREY

Punti di ancoraggio: 6  
 Fissaggio bretelle: staffa con foro diametro 8.5mm.  
 Fissaggio cosciali: doppia staffa con regolazione lunghezza con foro diametro 8.1mm.  
 Fissaggio addominali: staffa con foro da 11mm (7/16") e boccola di riduzione a 8.1mm  
 Regolatore professionale in alluminio.  
 Lingue allungate per alloggiare il loop.  
 Fibbia con mini-leva e guscio protettivo.  
 Nastro: 3"/2" con rinforzo ventrale.  
 Omologazione FIA 8853/98.

*Fixing points: 6  
 Shoulder strap fixing: 8.5mm diameter hole bracket.  
 Waist straps fixing: 11mm (7/16") diameter hole bracket with bush adapter to 8.1mm.  
 Crutch straps fixing: 8.1mm diameter hole double bracket for length adjustment.  
 Professional aluminium adjusters.  
 Longer tongues for loop housing.  
 Mini-lever and lever protection cover buckle.  
 Webbing: 3"/2" with waist load spreader  
 FIA Homologation: 8853/98.*



**904605E/1** ROSSO/RED  
**902605E/1** NERO/BLACK  
**901605E/1** BLU/BLUE  
**907605E/1** GRIGIO/GREY

Punti di ancoraggio: 6  
 Bretelle Hans® 3"/2"  
 Cintura utilizzabile solo in abbinamento al collare Hans®  
 Fissaggio bretelle: con loop, fissaggio con "osso di cane".  
 Fissaggio cosciali: doppia staffa con regolazione lunghezza con foro diametro 8.1mm.  
 Fissaggio addominali: staffa con foro da 11mm (7/16") e boccola di riduzione a 8.1mm  
 Regolatore professionale in alluminio.  
 Lingue allungate per alloggiare il loop.  
 Fibbia con mini-leva e guscio protettivo.  
 Nastro: 3"/2" con rinforzo ventrale.  
 Omologazione FIA 8853/98.  
 A richiesta, disponibile con staffe di fissaggio con foro 8.5mm su rami spalla.

*Fixing points: 6  
 Hans® 3"/2" shoulder straps  
 Harnesses to be used only in combination with Hans® device.  
 Shoulder strap fixing: Loop to be fixed with T-bone bracket.  
 Waist straps fixing: 11mm (7/16") diameter hole bracket with bush adapter to 8.1mm.  
 Crutch straps fixing: 8.1mm diameter hole double bracket for length adjustment.  
 Professional aluminium adjusters.  
 Longer tangs for loop housing.  
 Mini-lever and lever protection cover buckle.  
 Webbing: 3"/2" with waist load spreader  
 FIA Homologation: 8853/98  
 Upon request, it can be supplied with 8.5mm hole brackets on shoulder straps.*



**904226E** ROSSO/RED  
**902226E** NERO/BLACK  
**901226E** BLU/BLUE  
**907226E** GRIGIO/GREY

Punti di ancoraggio: 6  
 Fissaggio bretelle: loop, fissaggio con "osso di cane".  
 Fissaggio cosciali: doppia staffa con regolazione lunghezza con foro diametro 8.1mm.  
 Fissaggio addominali: liberi per fissaggio con doppia piastra.  
 Regolatore professionale in acciaio.  
 Lingue allungate per alloggiare il loop.  
 Fibbia con mini-leva e guscio protettivo.  
 Nastro: 3"/3".  
 Omologazione FIA 8853/98.

*Fixing points: 6*  
*Shoulder strap fixing: loop to be fixed with T-bone bracket.*  
*Waist straps fixing: free to be fixed by double plate.*  
*Crutch straps fixing: 8.1mm diameter hole double bracket for length adjustment.*  
*Professional steel adjusters.*  
*Longer tongues for loop housing.*  
*Mini-lever and lever protection cover buckle.*  
*Webbing: 3"/3"*  
*FIA Homologation: 8853/98.*



**904226E/4** ROSSO/RED  
**902226E/4** NERO/BLACK  
**901226E/4** BLU/BLUE  
**907226E/4** GRIGIO/GREY

Punti di ancoraggio: 6  
 Fissaggio bretelle: con loop, fissaggio con "osso di cane".  
 Fissaggio cosciali: doppia staffa con regolazione lunghezza con foro diametro 8.1mm.  
 Fissaggio addominali: liberi per fissaggio con doppia piastra.  
 Regolatore professionale in alluminio.  
 Lingue allungate per alloggiare il loop.  
 Fibbia con mini-leva e guscio protettivo.  
 Nastro: 3"/3".  
 Omologazione FIA 8853/98.

*Fixing points: 6*  
*Shoulder strap fixing: Loop to be fixed with T-bone bracket.*  
*Waist straps fixing: free to be fixed by double plate.*  
*Crutch straps fixing: 8.1mm diameter hole double bracket for length adjustment.*  
*Professional aluminium adjusters.*  
*Longer tongues for loop housing.*  
*Mini-lever and lever protection cover buckle.*  
*Webbing: 3"/3"*  
*FIA Homologation: 8853/98.*

# Cinture 6 punti 6 points Harnesses

**904600EA** ROSSO/RED  
**902600EA** NERO/BLACK  
**901600EA** BLU/BUE  
**907600EA** GRIGIO/GREY

Punti di ancoraggio: 6.  
Fissaggio bretelle addominali e cosciali:  
moschettoni con golfari a filetto 7/16" inclusi.  
Regolatori professionali in alluminio su bretelle  
e addominali.  
Nastro: 3"/3".  
Omologazione FIA 8853/98.  
Possibilità di rimozione dei moschettoni delle bretelle  
in caso di attacco roll bar.

*Fixing points: 6.  
Shoulder straps, waist and crutch straps fixing:  
snap hooks with 7/16" eyebolts included.  
Professional aluminium adjusters  
on shoulder and waist straps.  
Webbing: 3"/3".  
FIA 8853/98 approved.  
Snap hooks can be removed from shoulder straps  
in case of wrap around fixing.*



Tutte le cinture per berlina sono disponibili in versione per guida a destra  
(aggiungere D al codice al momento dell'ordine).

*All saloon harnesses are available in RHD version (add D to harness code when ordering).*

**904600E** ROSSO/RED  
**902600E** NERO/BLACK  
**901600E** BLU/BUE  
**907600E** GRIGIO/GREY

Punti di ancoraggio: 6.  
Fissaggio bretelle addominali e cosciali:  
moschettoni con golfari a filetto 7/16" inclusi.  
Regolatori professionali in alluminio su bretelle.  
Regolatori professionali in acciaio alleggerito  
su addominali.  
Nastro: 3"/3".  
Omologazione FIA 8853/98.  
Possibilità di rimozione dei moschettoni delle bretelle  
in caso di attacco roll bar.

*Fixing points: 6.  
Shoulder straps, waist and crutch straps fixing:  
snap hooks with 7/16" eyebolts included.  
Professional aluminium adjusters  
on shoulder straps.  
Professional steel adjusters  
on waist straps.  
Webbing: 3"/3".  
FIA 8853/98 approved.  
Snap hooks can be removed from shoulder straps  
in case of wrap around fixing.*



**904600EH1** ROSSO/RED  
**902600EH1** NERO/BLACK  
**901600EH1** BLU/BLUE  
**907600EH1** GRIGIO/GREY

Punti di ancoraggio: 6.  
 Bretelle Hans® 3"/2", attacco roll bar.  
 Cintura utilizzabile solo in abbinamento a collare Hans®.  
 Fissaggio addominali e cosciali: moschettoni con golfari a filetto 7/16" inclusi.  
 Regolatori professionali in alluminio su bretelle.  
 Regolatori professionali in acciaio alleggerito su addominali.  
 Nastro: 3"/3".  
 Omologazione FIA 8853/98.  
 Su richiesta fornitura dei moschettoni e golfari per fissaggio tradizionale.

*Fixing points: 6.  
 Hans® 3"/2" shoulder straps for wrap around fixing.  
 Harness to be used only in combination with Hans® device.  
 Waist and crutch straps fixing: snap books with 7/16" eyebolts included.  
 Professional aluminium adjusters on shoulder straps.  
 Professional steel adjusters on waist straps.  
 Webbing: 3"/3".  
 FIA 8853/98 approved.  
 Upon request we can supply the snap hooks and eye-bolts for normal fixing.*

**PULL UP**

**904600EH2** ROSSO/RED  
**902600EH2** NERO/BLACK  
**901600EH2** BLU/BLUE  
**907600EH2** GRIGIO/GREY

**PULL DOWN**

**904600EH2/1** ROSSO/RED  
**902600EH2/1** NERO/BLACK  
**901600EH2/1** BLU/BLUE  
**907600EH2/1** GRIGIO/GREY

Punti di ancoraggio: 8  
 Bretelle Hans® 3"/3"+ 2"  
 Cintura bretella doppia utilizzabile solo in abbinamento al collare Hans®  
 Fissaggio bretelle, addominali e cosciali: moschettoni con golfari a filetto 7/16" inclusi.  
 Regolatore professionale in alluminio sulle bretelle.  
 Regolatore professionale in acciaio sugli addominali.  
 Omologazione FIA 8853/98.

*Fixing points: 8  
 Hans® 3"/3"+ 2" shoulder straps  
 Double harness to be used in combination with Hans® device only.  
 Shoulder, waist and crutch straps fixing: snap hooks with 7/16" eyebolts included.  
 Professional aluminium adjusters on shoulder straps.  
 Professional steel adjusters on waist straps.  
 FIA Homologation: 8853/98*



- 904217E** ROSSO/RED  
**902217E** NERO/BLACK  
**901217E** BLU/BLUE  
**907217E** GRIGIO/GREY

Punti di ancoraggio: 6.  
 Fissaggio bretelle addominali e  
 cosciali: moschettoni con golfari a  
 filetto 7/16" inclusi.  
 Regolatori professionali in acciaio  
 alleggerito su addominali e bretelle.  
 Nastro: 3"/3".  
 Omologazione FIA 8853/98.

*Fixing points: 6.  
 Shoulder straps, waist  
 and crutch straps fixing:  
 snap hooks with 7/16"  
 eyebolts included.  
 Professional steel adjusters on shoulder  
 and waist straps.  
 Webbing: 3"/3".  
 FIA 8853/98 approved.*



- 904217EPACK** ROSSO/RED  
**902217EPACK** NERO/BLACK  
**901217EPACK** BLU/BLUE  
**907217EPACK** GRIGIO/GREY

La confezione comprende 2 cinture ad un prezzo speciale.

Package including two harnesses with a special price.



904217E/4 ROSSO/RED  
 902217E/4 NERO/BLACK  
 901217E/4 BLU/BLUE  
 907217E/4 GRIGIO/GREY

Punti di ancoraggio: 6.

Fissaggio bretelle: attacco roll bar.

Fissaggio addominali e cosciali: moschettoni con golfari a filetto 7/16" inclusi.

Regolatori professionali in acciaio alleggerito su addominali e bretelle.

Nastro: 3"/3".

Omologazione FIA 8853/98.

*Fixing points: 6.*

*Shoulder straps: wrap around.*

*Waist and crutch straps fixing: snap hooks with 7/16" eyebolts included.*

*Professional steel adjusters on shoulder and waist straps.*

*Webbing: 3"/3".*

*FIA 8853/98 approved.*



904138E ROSSO/RED  
 902138E NERO/BLACK  
 901138E BLU/BLUE  
 907138E GRIGIO/GREY

Punti di ancoraggio: 6.

Fissaggio bretelle addominali e cosciali: moschettoni con golfari a filetto 7/16" inclusi.

Regolatori professionali in acciaio alleggerito su bretelle.

Regolatori buflug su addominali.

Nastro: 3"/2" con rinforzo ventrale. Omologazione FIA 8853/98.

*Fixing points: 6.*

*Shoulder straps, waist and crutch straps fixing: snap hooks with 7/16" eyebolts included.*

*Professional steel adjusters on shoulder straps.*

*Buflug pull-down adjusters on lap straps.*

*Webbing: 3"/2" with waist load spreader. FIA 8853/98 approved.*

# Cinture omologate SFI SFI homologated Harnesses



**CFC10072/1** ROSSO/RED  
**CFC12072/1** NERO/BLACK

Punti di ancoraggio: 6.  
Fissaggio bretelle addominali e cosciali: staffa di montaggio con rondella da foro 3/8"  
Regolatori professionali in alluminio su bretelle con nastro 2"/3"  
Ramo addominale (lato destro): regolatore acciaio, pull up  
Ramo addominale (lato sinistro): regolatore 3-bar  
Omologazione SFI 16.5

*Fixing points: 6.  
Shoulder straps, waist and crutch straps fixing: mounting brackets with bush and washer for 3/8" bolt.  
Shoulder straps: aluminium quick release adjuster with 2"/3" webbing  
Waist strap (right side): steel adjuster, pull up  
Waist strap (left side): 3-bar adjuster.  
SFI 16.5 approved.*



**CFC10071/1** ROSSO/RED  
**CFC12071/1** NERO/BLACK

Punti di ancoraggio: 6.  
Fissaggio bretelle, addominali e cosciali: staffa di montaggio con rondella da foro 3/8"  
Regolatori professionali in acciaio su bretelle con nastro 2"/3"  
Ramo addominale (lato destro): regolatore acciaio, pull up  
Ramo addominale (lato sinistro): regolatore 3-bar  
Omologazione SFI 16.5

*Fixing points: 6.  
Shoulder straps, waist and crutch straps fixing: mounting brackets with bush and washer for 3/8" bolt.  
Shoulder straps: steel adjuster with 2"/3" webbing  
Waist strap (right side): steel adjuster, pull up  
Waist strap (left side): 3-bar adjuster.  
SFI 16.5 approved.*

**CFCI0072** ROSSO/RED  
**CFCI2072** NERO/BLACK

Punti di ancoraggio: 6.  
 Fissaggio bretelle addominali e cosciali  
 staffa di montaggio con rondella da foro 3/8"  
 Regolatori professionali in alluminio su bretella  
 con nastro 2"/3"  
 Ramo addominale (lato destro):  
 regolatore acciaio, pull down  
 Ramo addominale (lato sinistro): regolatore 3-bar  
 Omologazione SFI 16.5

*Fixing points: 6.*

*Shoulder straps, waist and crutch straps fixing:  
 mounting brackets with bush and washer  
 for 3/8" bolt.*

*Shoulder straps: aluminium quick release adjuster with 2"/3" webbing*

*Waist strap (right side): steel adjuster, pull down*

*Waist strap (left side): 3-bar adjuster.*

*SFI 16.5 approved.*



**CFCI0071** ROSSO/RED  
**CFCI2071** NERO/BLACK

Punti di ancoraggio: 6.  
 Fissaggio bretelle, addominali e cosciali:  
 staffa di montaggio con rondella da foro 3/8"  
 Regolatori professionali in acciaio su bretelle  
 con nastro 2"/3"  
 Ramo addominale (lato destro):  
 regolatore acciaio, pull down  
 Ramo addominale (lato sinistro):  
 regolatore 3-bar  
 Omologazione SFI 16.5

*Fixing points: 6.*

*Shoulder straps, waist and crutch straps fixing:  
 mounting brackets with bush and washer  
 for 3/8" bolt.*

*Shoulder straps: steel adjuster with 2"/3" webbing*

*Waist strap (right side): steel adjuster, pull down*

*Waist strap (left side): 3-bar adjuster.*

*SFI 16.5 approved.*



**CFCI0072/2** ROSSO/RED  
**CFCI2072/2** NERO/BLACK

Punti di ancoraggio: 6.

Fissaggio bretelle addominali e cosciali  
staffa di montaggio con rondella da foro 3/8"

Regolatori professionali in alluminio su bretella  
con nastro 2"/3"

Ramo addominale (lato destro): regolatore 3-bar

Ramo addominale (lato sinistro): regolatore 3-bar

Omologazione SFI 16.5

*Fixing points: 6.*

*Shoulder straps, waist and crutch straps fixing:  
mounting brackets with bush and washer  
for 3/8" bolt.*

*Shoulder straps: aluminium quick release adjuster with 2"/3" webbing*

*Waist strap (right side): 3-bar adjuster.*

*Waist strap (left side): 3-bar adjuster.*

*SFI 16.5 approved.*



**CFCI0071/2** ROSSO/RED  
**CFCI2071/2** NERO/BLACK

Punti di ancoraggio: 6.

Fissaggio bretelle, addominali e cosciali:

staffa di montaggio con rondella da foro 3/8"

Regolatori professionali in acciaio su bretelle  
con nastro 2"/3"

Ramo addominale (lato destro):

regolatore 3-bar

Ramo addominale (lato sinistro):

regolatore 3-bar

Omologazione SFI 16.5

*Fixing points: 6.*

*Shoulder straps, waist and crutch straps fixing:  
mounting brackets with bush and washer  
for 3/8" bolt.*

*Shoulder straps: steel adjuster with 2"/3" webbing*

*Waist strap (right side): 3-bar adjuster*

*Waist strap (left side): 3-bar adjuster.*

*SFI 16.5 approved.*



## Cinture 4 punti 4 points Harnesses



**904570E** ROSSO/RED  
**902570E** NERO/BLACK  
**901570E** BLU/BLUE  
**907570E** GRIGIO/GREY

Punti di ancoraggio: 4.  
 Fissaggio bretelle e addominali: moschettoni con golfari a filetto 7/16" inclusi.  
 Regolatori professionali in alluminio su bretelle.  
 Regolatori professionali in acciaio alleggerito su addominali.  
 Nastro: 3"/3".  
 Omologazione FIA 8854/98.

*Fixing points: 4.  
 Shoulder and waist straps fixing: snap hooks with 7/16" eyebolts included.  
 Professional aluminium adjusters on shoulder straps.  
 Professional steel adjusters on lap straps.  
 Webbing: 3"/3".  
 FIA 8854/98 approved.*



**904571E** ROSSO/RED  
**902571E** NERO/BLACK  
**901571E** BLU/BLUE  
**907571E** GRIGIO/GREY

Punti di ancoraggio: 4  
 Fissaggio bretelle: attacco roll bar  
 Fissaggio addominali:

moschettoni con golfari a filetto 7/16" inclusi  
 Regolatori professionali in alluminio su bretelle.  
 Regolatori professionali in acciaio alleggerito su addominali.  
 Nastro: 3"/3".  
 Omologazione FIA 8854/98.

*Fixing points: 4  
 Shoulder straps fixing: wrap around.  
 Waist straps fixing: snap hooks with 7/16" eyebolts included.  
 Professional aluminium adjusters on shoulder straps.  
 Professional steel adjusters on lap straps.  
 Webbing: 3"/3".  
 FIA 8854/98 approved.*





- 904183E** ROSSO/RED
- 902183E** NERO/BLACK
- 901183E** BLU/BLUE
- 907183E** GRIGIO/GREY

Punti di ancoraggio: 4  
 Fissaggio bretelle e addominali: moschettoni con golfari a filetto 7/16" inclusi.  
 Regolatori professionali in acciaio alleggerito su bretelle e addominali.  
 Nastro: 3"/3".  
 Omologazione FIA 8854/98.

*Fixing points: 4*  
*Shoulder and waist straps fixing: snap hooks with 7/16" eyebolts included.*  
*Professional steel adjusters on shoulder and lap straps.*  
*Webbing: 3"/3"*  
*FIA 8854/98 approved.*



- 904183EPACK** ROSSO/RED
- 902183EPACK** NERO/BLACK
- 901183EPACK** BLU/BLUE
- 907183EPACK** GRIGIO/GREY

La confezione comprende 2 cinture ad un prezzo speciale.

*Package including two harnesses with a special price.*

**904183E/1** ROSSO/RED  
**902183E/1** NERO/BLACK  
**901183E/1** BLU/BLE  
**907183E/1** GRIGIO/GREY

Versione con regolazione verso il basso della cintura -183E.

*Pull down version of -183E model.*



**904118E** ROSSO/RED  
**902118E** NERO/BLACK  
**901118E** BLU/BLE  
**907118E** GRIGIO/GREY

Punti di ancoraggio: 4.  
 Bretelle regolabili.  
 Fissaggio bretelle e addominali: moschettoni con golfari a filetto 7/16" inclusi.  
 Regolatori professionali in acciaio alleggerito su bretelle.  
 Regolatori buflug su addominali.  
 Nastro: 3"/2" con rinforzo ventrale.  
 Omologazione FIA 8854/98.

*Fixing points: 4.  
 Adjustable shoulder straps.  
 Shoulder and waist straps fixing: snap books with 7/16" eyebolts included.  
 Professional steel adjusters on shoulder straps.  
 Buflug pull-down adjusters on lap straps.  
 Webbing: 3"/2" with waist load spreader.  
 FIA 8854/98 approved.*



**904119E** ROSSO/RED  
**902119E** NERO/BLACK  
**901119E** BLU/BLE  
**907119E** GRIGIO/GREY

Punti di ancoraggio: 4  
 Fissaggio bretelle e addominali: moschettoni con golfari a filetto 7/16" inclusi  
 Regolatori professionali in acciaio alleggerito su bretelle.  
 Regolatori buflug su addominali.  
 Nastro: 3"/2" con rinforzo ventrale.  
 Omologazione FIA 8854/98.

*Fixing points: 4  
 Shoulder and waist straps fixing: snap books with 7/16" eyebolts included.  
 Professional steel adjusters on shoulder straps.  
 Buflug pull-down adjusters on lap straps.  
 Webbing: 3"/2" with waist load spreader  
 FIA 8854/98 approved.*



# Cinture Westfield *Westfield harnesses*

- CFCI0033/3** ROSSO/RED
- CFCI1033/3** BLU/BLUE
- CFCI2033/3** NERO/BLACK
- CFCI7033/3** GRIGIO/GREY

Punti di fissaggio 4.

Attacchi bretelle: moschettoni con golfari a filetto 7/16" inclusi lunghezza 50mm.

Attacchi addominali: staffe con viti 7/16" incluse.

Bretelle: regolatori in alluminio professionali.

Addominali: regolatori in acciaio con regolazione verso il basso.

Nastro 3"/3". Omologazione FIA 8854/98.

*Fixing points: 4*

*Shoulder straps fixing: snap hook with 7/16" eye bolts length 50mm included.*

*Waist straps fixing: brackets with 7/16" bolts included*

*Shoulder straps: Aluminium adjusters.*

*Waist strap: Steel adjusters.*

*Webbing 3"/3". Pull down.*

*FIA standard 8854/98 Approved.*



- CFCI0033D/3** ROSSO/RED
- CFCI1033D/3** BLU/BLUE
- CFCI2033D/3** NERO/BLACK
- CFCI7033D/3** GRIGIO/GREY

Versione per guida a destra

*RHD version*



- CFCI0034/3** ROSSO/RED
- CFCI1034/3** BLU/BLUE
- CFCI2034/3** NERO/BLACK
- CFCI7034/3** GRIGIO/GREY

Versione con addominale 2".

*2" lap strap version.*

- CFCI0034D/3** ROSSO/RED
- CFCI1034D/3** BLU/BLUE
- CFCI2034D/3** NERO/BLACK
- CFCI7034D/3** GRIGIO/GREY

Versione per guida a destra

*RHD version*

- CFCI0033D** ROSSO/RED
- CFCI1033D** BLU/BLUE
- CFCI2033D** NERO/BLACK
- CFCI7033D** GRIGIO/GREY

Versione per guida a destra

*RHD version*

- CFCI0033** ROSSO/RED
- CFCI1033** BLU/BLUE
- CFCI2033** NERO/BLACK
- CFCI7033** GRIGIO/GREY

Punti di fissaggio 4

Attacchi bretelle: moschettoni con golfari a filetto 7/16" inclusi lunghezza 50mm.

Attacchi addominali: staffe con viti 7/16" incluse

Regolatori in acciaio. Nastro 3"/3". Regolazione verso il basso

Omologazione FIA 8854/98

*Fixing points:4*

*Shoulder straps fixing: snap hook with 7/16" eye bolts length 50mm included.*

*Waist straps fixing: brackets with 7/16" bolts included*

*Steel adjusters. Webbing 3"/3". Pull down*

*FIA standard 8854/98 Approved.*

- CFCI0034D** ROSSO/RED
- CFCI1034D** BLU/BLUE
- CFCI2034D** NERO/BLACK
- CFCI7034D** GRIGIO/GREY

Versione per guida a destra

*RHD version*

- CFCI0034** ROSSO/RED
- CFCI1034** BLU/BLUE
- CFCI2034** NERO/BLACK
- CFCI7034** GRIGIO/GREY

Versione con addominale 2".

*2" lap strap version.*



# Cinture Caterham Caterham harnesses

**CFCI0033/2** ROSSO/RED  
**CFCI1033/2** BLU/BLUE  
**CFCI2033/2** NERO/BLACK  
**CFCI7033/2** GRIGIO/GREY

Punti di fissaggio 4  
 Attacchi bretelle e addominali:  
 staffe con viti 7/16" incluse  
 Regolatori in acciaio  
 Nastro 3"/3"  
 Regolazione verso il basso  
 Omologazione FIA 8854/98.

*Fixing points: 4*  
*Shoulder and waist straps fixing: brackets*  
*with 7/16" bolts included*  
*Steel adjusters*  
*Webbing 3"/3"*  
*Pull down*  
*FIA standard 8854/98 Approved*

**CFCI0033D/2** ROSSO/RED  
**CFCI1033D/2** BLU/BLUE  
**CFCI2033D/2** NERO/BLACK  
**CFCI7033D/2** GRIGIO/GREY

Versione per guida a destra

*RHD version*



**CFCI0034/2** ROSSO/RED  
**CFCI1034/2** BLU/BLUE  
**CFCI2034/2** NERO/BLACK  
**CFCI7034/2** GRIGIO/GREY

Versione con addominale 2".

*2" lap strap version.*

**CFCI0034D/2** ROSSO/RED  
**CFCI1034D/2** BLU/BLUE  
**CFCI2034D/2** NERO/BLACK  
**CFCI7034D/2** GRIGIO/GREY

Versione per guida a destra

*RHD version*



**CFCI0033D/1** ROSSO/RED  
**CFCI1033D/1** BLU/BLUE  
**CFCI2033D/1** NERO/BLACK  
**CFCI7033D/1** GRIGIO/GREY

Versione per guida a destra

*RHD version*

**CFCI0033/1** ROSSO/RED  
**CFCI1033/1** BLU/BLUE  
**CFCI2033/1** NERO/BLACK  
**CFCI7033/1** GRIGIO/GREY

Punti di fissaggio 4  
 Attacchi bretelle: staffe con viti da 7/16" incluse.  
 Attacchi addominali: staffe con viti 7/16" incluse  
 Bretelle: Regolatori in alluminio professionali  
 Addominali: Regolatori in acciaio.  
 Nastro 3"/3". Regolazione verso il basso.  
 Omologazione FIA 8854/98.

*Fixing points: 4*  
*Shoulder straps fixing: brackets with 7/16" bolts*  
*included.*  
*Waist straps fixing: brackets with 7/16" bolts included*  
*Shoulder straps: Aluminium adjusters*  
*Waist strap: Steel adjusters*  
*Webbing 3"/3". Pull down*  
*FIA standard 8854/98 Approved*

**CFCI0034D/1** ROSSO/RED  
**CFCI1034D/1** BLU/BLUE  
**CFCI2034D/1** NERO/BLACK  
**CFCI7034D/1** GRIGIO/GREY

Versione per guida a destra

*RHD version*

**CFCI0034/1** ROSSO/RED  
**CFCI1034/1** BLU/BLUE  
**CFCI2034/1** NERO/BLACK  
**CFCI7034/1** GRIGIO/GREY

Versione con addominale 2".

*2" lap strap version.*



# Misure cinture Harnesses measurements

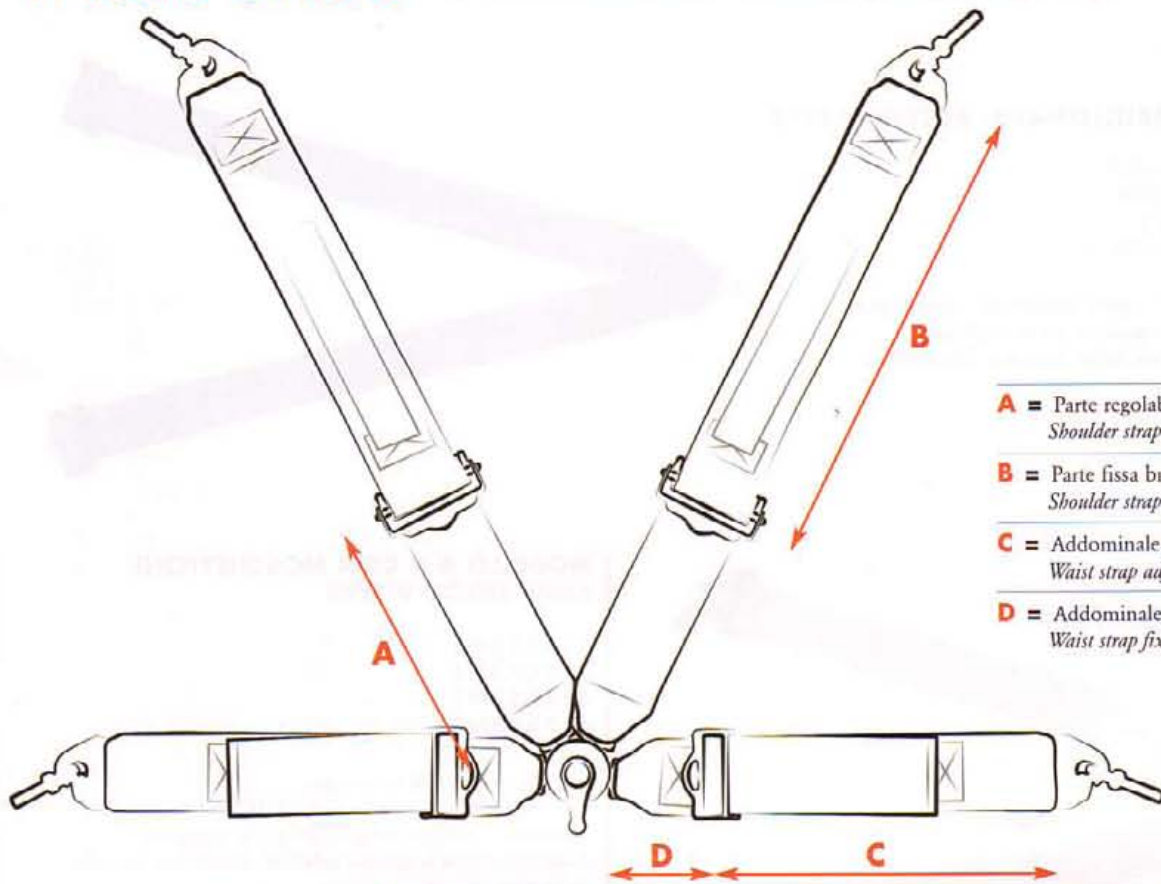

- A** = Parte regolabile bretella tutta estratta  
*Shoulder strap adjustable part fully extended.*
- B** = Parte fissa bretella  
*Shoulder strap fixed part.*
- C** = Addominale parte regolabile tutto estratto  
*Waist strap adjustable part fully extended.*
- D** = Addominale parte fissa  
*Waist strap fixed part.*

	A	B	C	D
<b>MONOPOSTO</b>				
<b>904604E</b>	400	450	560 = C+D	
<b>904605E</b>	400	450	560 = C+D	
<b>904605E/1</b>	400	450	560 = C+D	
<b>904226E</b>	380	560	610 = C+D	
<b>904226E/4</b>	380	560	610 = C+D	

<b>BERLINA</b>					
<b>904600EA</b>	1620	390	620	130	PULL UP
<b>904600EH1</b>	1620	390	620	130	PULL UP
<b>904217E</b>	1620	390	620	130	PULL UP
<b>904217E/4</b>	1620	390	620	130	PULL UP
<b>904138E</b>	1580	390	620	130	PULL DOWN
<b>904570E</b>	1620	390	620	130	PULL UP
<b>904571E</b>	1460	390	620	130	PULL UP
<b>904183E</b>	1620	390	620	130	PULL UP
<b>904183E/1</b>	1620	390	620	130	PULL DOWN
<b>904118E</b>	1580	390	580	120	PULL UP
<b>904119E</b>	525	390	590	120	PULL UP

<b>WESTFIELD</b>					
<b>CFCI0033</b>	430	480	610	130	PULL DOWN
<b>CFCI0033/3</b>	430	480	610	130	PULL DOWN
<b>CFCI0034</b>	430	480	610	130	PULL DOWN
<b>CFCI0034/3</b>	430	480	610	130	PULL DOWN

<b>CATERHAM</b>					
<b>CFCI0033/1</b>	430	480	610	130	PULL DOWN
<b>CFCI0033/2</b>	430	480	610	130	PULL DOWN
<b>CFCI0034/1</b>	430	480	610	130	PULL DOWN
<b>CFCI0034/2</b>	430	480	610	130	PULL DOWN

Tutte le misure sono espresse in mm. All measurements are expressed in mm

# Cosciali Crutch Straps

## MODELLO A V IMBULLONATO BOLT-IN V-TYPE

- 414853E** ROSSO/RED  
**412853E** NERO/BLACK  
**411853E** BLU/BLUE  
**417853E** GRIGIO/GREY

Cosciale con 2 punti di fissaggio imbullonati e minilingua. Nastro da 2", munito di regolatore per la lunghezza. Adattabile a tutta la gamma Sabelt di cinture Top Formula per berlina.

*V-type crutch strap bolt-in.  
2" webbing, adjustable length.  
Fits to all Sabelt range of Top Formula harnesses for saloon cars.*



## MODELLO A V CON MOSCHETTONI SNAP HOOK V-TYPE

- 414853ME** ROSSO/RED  
**412853ME** NERO/BLACK  
**411853ME** BLU/BLUE  
**417853ME** GRIGIO/GREY

Cosciale con 2 punti di fissaggio a moschettoni con golfari a filetto 7/16" inclusi, Nastro da 2", munito di regolatore per la lunghezza. Adattabile a tutta la gamma Sabelt di cinture Top Formula per berlina.

*V-type crutch strap.  
Snap hook fixing with 7/16" eyebolt included.  
2" webbing adjustable length.  
Fits to all Sabelt range of Top Formula harnesses for saloon cars.*



## MODELLO T T-TYPE

- 414850E** ROSSO/RED  
**412850E** NERO/BLACK  
**411850E** BLU/BLUE  
**417850E** GRIGIO/GREY

Cosciale con 2 punti di fissaggio a moschettoni con golfari a filetto 7/16" inclusi, nastro da 2", munito di regolatore per la lunghezza. Nuovo mini baffo anatomico. Adattabile a tutta la gamma di cinture Top Formula per berlina.

*T-type crutch strap.  
Snap hook fixing with 7/16" eyebolt included.  
Adjustable length. New anatomical T-bar.  
2" webbing.  
Fits to all Sabelt range of Top Formula harnesses for saloon cars.*



## MODELLO I NEGATIVE G-STRAP

- 414851E** ROSSO/RED  
**412851E** NERO/BLACK  
**411851E** BLU/BLUE  
**417851E** GRIGIO/GREY

Cosciale con 1 punto di fissaggio a moschettoni con golfari a filetto 7/16" inclusi, nastro da 2", munito di regolatore per la lunghezza. Adattabile a tutta la gamma di cinture Top Formula per berlina.

*I-type crutch strap.  
Snap hook fixing with 7/16" eyebolt included.  
Adjustable length. Plug-in mini-tang.  
2" webbing.  
Fits to all Sabelt range of Top Formula harnesses for saloon cars.*



# Coprispalla Pads



**F1**

**475140** ROSSO/RED  
**475120** NERO/BLACK  
**475110** BLU/BLUE

Coprispalla in tessuto Nomex® ignifugo.  
 Larghezza 75 mm (3").  
 Con cerniera e protezione per regolatore.

*Nomex® fireproof fabric shoulder pad.  
 75 mm (3") width.  
 With zip and adjusters protection.*



**75 MM.**

**475040** ROSSO/RED  
**475020** NERO/BLACK  
**475010** BLU/BLUE

Coprispalla in tessuto Vep.  
 Larghezza 75 mm (3").  
 Chiusura con velcro.

*Vep fabric shoulder cover.  
 75 mm (3") width.  
 Velcro fastening.*



**T 75**

**475240** ROSSO/RED  
**475220** NERO/BLACK  
**475230** BLU/BLUE

Coprispalla in tessuto Vep  
 con protezione per regolatore.  
 Larghezza 75 mm (3").  
 Chiusura con velcro.

*Vep fabric shoulder pad with adjuster  
 protection.  
 75 mm (3") width.  
 Velcro fastening.*

# Golfari e piastre Eye bolts and plates



**CCM10018**

Vite ad occhio diam. 7/16" UNF, lungh. filetto 32 mm, classe di resistenza 8.8.

*Eye-bolt 7/16" UNF, thread length 32 mm, 8.8*



**METRIC M10 X 1,25  
 CCM10023**

Vite ad occhio a filetto metrico M10 x 1.51, lunghezza 23 mm classe di resistenza 8.8. Non conforme FIA.

*Eye-bolt metric M10 x 1.51 thread length 23 mm, 8.8.  
 Does not comply with FIA requirements.*



**407005**

Vite ad occhio standard diam. 7/16" filetto UNF, lungh. filetto 23 mm, lungh. totale 25 mm. Classe di resistenza 8.8.

*Standard eye-bolt diam. 7/16" UNF thread length 23 mm, 25 mm tot. 8.8.*



**SB/2049**

Piastra di rinforzo 50 x 25 x 6 m, 7/16" filetto UNF. Non conforme FIA.

*Eye bolt back plate 50 x 25 mm, 6 mm thick, 7/16" UNF thread. Does not comply with FIA requirements.*



**CCM10019** Disponibile su richiesta  
*Available on request*

Vite ad occhio in titanio diam. 7/16" filetto UNF, lungh. filetto 23 mm, lungh. totale 25 mm.

*Eye-bolt diam. 7/16" UNF thread length 23 mm, 25 mm tot, TITANIUM.*



**CCM10017 - WESTFIELD**

Vite ad occhio lungh. 50 mm., diam. 7/16", classe di resistenza 8.8

*Eye-bolt 50 mm. long, 7/16", 8.8*



**CCM10016**

Piastra di rinforzo per vite ad occhio 7/16" filetto UNF con dado saldato misura 65 x 65 x 3 mm a norma FIA (superficie 40 mm²).

*Eye-bolt back plate 65 mm x 65 mm x 3 mm 7/16" UNF thread welded nut, 40 mm².  
 Complies with FIA requirements.*

# CLUBMAN

## CLUBMAN

La nuova gamma di cinture "Clubman" per uso stradale è omologata ECE 16; le cinture sono disponibili nella configurazione a 3 punti di ancoraggio (numero di omologazione 16R-04 0688) e a 4 punti di ancoraggio (numero di omologazione 16R-04 0689).

Il nastro utilizzato ha larghezza 2" (disponibile nei colori blu, grigio, nero e rosso) ed è il medesimo utilizzato nella produzione delle cinture da competizione.

I regolatori sia sulle bretelle che sugli addominali sono gli stessi di quelli utilizzati nelle cinture professionali da competizione e la configurazione dei rami addominali con regolatori su entrambi i lati è tale da mantenere la fibbia sempre in posizione simmetrica rispetto al pilota.

*The new range of clubman harnesses for road use is ECE 16 approved; harnesses are available in 3 points (homologation number 16R-04 0688) and 4 points version (homologation number 16R-04 0689).*

*The webbing is 2" width (available in red, black, blue and grey) and it is the same used in competition harnesses production; in the same way as the shoulder and lap straps adjusters are the same used for Top Formula harnesses.*

*Thanks to the adjusters located on both sides, aap straps guarantee a perfect quick adjustment and fitting, maintaining the buckle on the centre of the body, thus avoiding possible safety or fitting problems.*



**904075N** ROSSO/RED  
**902075N** NERO/BLACK  
**901075N** BLU/BLUE  
**907075N** GRIGIO/GREY

Punti ancoraggio: 4.  
 Fissaggio bretelle: una staffa fissa e una regolabile.  
 Fissaggio addominali: moschettoni.  
 Omologata Ece.

Fixing point: 4.  
 Shoulder straps fixing: one adjustable and one fix bracket.  
 Waist straps: snap hook with 7/16" eyebolt included.  
 Ece approved.



**902** NERO/BLACK



**901** BLU/BLUE



**907** GRIGIO/GREY



**904** ROSSO/RED



TUTTE LE CINTURE SONO DISPONIBILI IN QUATTRO DIVERSI COLORI  
 ALL HARNESSSES ARE AVAILABLE IN THREE DIFFERENT COLOURS

# Cinture 4 punti 4 points Harnesses

- 904001N** ROSSO/RED
- 902001N** NERO/BLACK
- 901001N** BLU/BUE
- 907001N** GRIGIO/GREY

Punti ancoraggio: 4.  
Fissaggio bretelle: staffe regolabili.  
Fissaggio addominali: staffe fisse.  
Omologata Ece.

*Fixing points: 4.  
Shoulder strap fixing: adjustable brackets.  
Waist straps fixing: brackets.  
Ece approved.*



- 904020NP** ROSSO/RED
- 902020NP** NERO/BLACK
- 901020NP** BLU/BUE
- 907020NP** GRIGIO/GREY

Punti ancoraggio: 4.  
Fissaggio bretelle: staffe regolabili.  
Fissaggio addominali: staffe fisse.  
Omologata Ece.  
Coprispalla inclusi nel prezzo.

*Fixing points: 4.  
Shoulder strap fixing: adjustable brackets.  
Waist straps fixing: brackets.  
Ece approved.  
Pads included.*



- 904070NP** ROSSO/RED  
**902070NP** NERO/BLACK  
**901070NP** BLU/BLUE  
**907070NP** GRIGIO/GREY

Punti ancoraggio: 4.  
 Fissaggio bretelle e addominali: moschettoni con golfari a filetto 7/16" inclusi.  
 Omologata Ece.  
 Coprispalla inclusi nel prezzo.

*Fixing points: 4.  
 Shoulder strap and waist straps fixing:  
 snap hook with 7/16" eyebolt included.  
 Ece approved.  
 Pad included.*



- 904118Z** ROSSO/RED  
**902118Z** NERO/BLACK  
**901118Z** BLU/BLUE  
**907118Z** GRIGIO/GREY

Punti ancoraggio: 4.  
 Fissaggio bretelle e addominali: moschettoni con golfari a filetto 7/16" inclusi.  
 Fibbia tipo competizione con minilingue.  
 Non omologata.

*Fixing points: 4.  
 Shoulder strap and waist straps fixing:  
 snap hook with 7/16" eyebolt included.  
 Racing buckle with mini-tangs.  
 Not homologated.*



## Cintura Caterham Caterham harness

**904076N/1** ROSSO/RED  
**902076N/1** NERO/BLACK  
**901076N/1** BLU/BLE  
**907076N/1** GRIGIO/GREY

Punti ancoraggio: 4.  
Fissaggio bretelle e addominali: staffe fisse.  
Regolazione verso il basso.  
Omologata Ece per uso specifico.

*Fixing points: 4.  
Shoulder strap and waist straps fixing: bolt-in.  
Pull down.  
Ece approved for specific use.*

**ECE**



## Cintura Westfield Westfield harness

**904076N/3** ROSSO/RED  
**902076N/3** NERO/BLACK  
**901076N/3** BLU/BLE  
**907076N/3** GRIGIO/GREY

Punti ancoraggio: 4.  
Fissaggio bretelle: moschettoni con golfari a filetto 7/16"  
lunghezza 50mm inclusi.  
Fissaggio addominali: staffe fisse.  
Regolazione verso il basso.  
Omologata Ece per uso specifico.

*Fixing points: 4.  
Shoulder straps fixing: snap book with 7/16" 50mm  
length eyebolts included.  
Waist straps fixing: bolt-in.  
Pull down.  
Ece approved for specific use.*

**ECE**



Regolazione verso il basso *Pull down*

**904086N/1** ROSSO/RED  
**902086N/1** NERO/BLACK  
**901086N/1** BLU/BLEUE  
**907086N/1** GRIGIO/GREY

Punti ancoraggio: 4.  
 Fissaggio bretelle: staffe regolabili.  
 Fissaggio addominali: staffe fisse.  
 Omologata Ece.

*Fixing points: 4.  
 Shoulder straps fixing: adjustable brackets.  
 Lap straps fixing: brackets.  
 Ece approved.*

**904086N/4** ROSSO/RED  
**902086N/4** NERO/BLACK  
**901086N/4** BLU/BLEUE  
**907086N/4** GRIGIO/GREY

Versione con staffe sulle bretelle e fissaggio a moschettoni sugli addominali.  
 Regolazione verso il basso.  
 Omologata ECE.

*Brackets on shoulder straps and lap straps snap hooks fixing.  
 Pull down.  
 Ece approved.*



**904086N/3** ROSSO/RED  
**902086N/3** NERO/BLACK  
**901086N/3** BLU/BLEUE  
**907086N/3** GRIGIO/GREY

Punti ancoraggio: 4.  
 Fissaggio bretelle: moschettoni.  
 Fissaggio addominali: staffe fisse.  
 Omologata Ece.

*Fixing points: 4.  
 Shoulder straps fixing: snap hooks.  
 Lap straps fixing: brackets.  
 Ece approved.*

**904086N/2** ROSSO/RED  
**902086N/2** NERO/BLACK  
**901086N/2** BLU/BLEUE  
**907086N/2** GRIGIO/GREY

Versione con fissaggio a moschettoni sia sulle bretelle che sugli addominali.  
 Regolazione verso il basso.  
 Omologata ECE.

*Shoulder and lap straps snap hook fixing version.  
 Pull down.  
 Ece approved.*

# Cinture 3 punti 3 points Harnesses

**904002NP** ROSSO/RED  
**902002NP** NERO/BLACK  
**901002NP** BLU/BLE  
**907002NP** GRIGIO/GREY

Punti ancoraggio: 3.  
Fissaggio bretelle: staffa regolabile.  
Fissaggio addominali: staffe fisse.  
Omologata Ece.  
Coprispalla inclusi nel prezzo.

Fixing point: 3.  
Shoulder straps fixing: adjustable bracket.  
Lap straps fixing: brackets.  
Ece approved.  
Pad included.



**904059NP** ROSSO/RED  
**902059NP** NERO/BLACK  
**901059NP** BLU/BLE  
**907059NP** GRIGIO/GREY

Punti ancoraggio: 3.  
Doppia fibbia per consentire accesso al sedile posteriore.  
Fissaggio bretelle: staffa regolabile.  
Fissaggio addominali: moschettoni con golfari a filetto 7/16" inclusi.  
Omologata Ece.  
Coprispalla inclusi nel prezzo.

Fixing point: 3.  
Double release buckle.  
Shoulder strap fixing: adjustable bracket.  
Waist straps: snap hook with 7/16" eyebolt included.  
Ece approved.  
Pad included.



**904005N** ROSSO/RED  
**902005N** NERO/BLACK  
**901005N** BLU/BLUE  
**907005N** GRIGIO/GREY

Punti ancoraggio: 3.  
 Fissaggio bretelle e addominali: moschettoni  
 con golfari a filetto 7/16" inclusi.  
 Omologata Ece.

*Fixing point: 3.  
 Shoulder strap and waist straps fixing: snap hook with 7/16"  
 eyebolt included.  
 Ece approved.*



**904019N** ROSSO/RED  
**902019N** NERO/BLACK  
**901019N** BLU/BLUE  
**907019N** GRIGIO/GREY

Punti ancoraggio: 3.  
 Fissaggio bretelle: staffa regolabile  
 Fissaggio addominali: staffe fisse.  
 Omologata Ece.

*Fixing point: 3.  
 Shoulder strap fixing: adjustable bracket.  
 Waist straps fixing: brackets.  
 Ece approved.*



# Coprispalla Pads

- 450040** ROSSO/RED
- 450020** NERO/BLACK
- 450010** BLU/BLUE
- 450070** GRIGIO/GREY

Coprispalla in tessuto vep.  
Larghezza 50 mm (2").  
Chiusura con velcro.

*Vep fabric shoulder pads.  
Width: 2".  
Velcro fastening.*



## VITI DISPONIBILI SU RICHIESTA (NO FIA)

- CCMI0022** Vite metric M10 x 1.50
- 33027782** Stilo 3 porte: lungh. 23 mm a brugola M10 x 1.25;
- 33021554** Lungh. 28 M10 x 1.25;
- 33027082** esagonale M10 x 1.25, specifica Ford a brugola.

## BOLTS AVAILABLE UPON REQUEST (NO FIA)

- CCMI0022** Bolt metric M10 x 1.50
- 33027782** Stilo 3 doors: length 23 mm allen screw M10 x 1.25;
- 33021554** Length 28 M10 x 1.25;
- 33027082** Hexagonal M10 x 1.25, specific Ford bolts.

## ESPOSITORE DA BANCO DISPLAYS FOR SHOULDER PADS

Contiene 12 paia di coprispalla: 8 rossi, 2 neri e 2 blu.

*It contains 12 pairs of pads: 8 red, 2 black and 2 blue.*

## INDICE INDEX

p. 42	<b>TUTE</b> <b>SUITS</b>
p. 43	<b>LABORATORIO TUTE</b> <b>SUIT LAB</b>
p. 44	<b>TUTE FIA</b> <b>FIA SUITS</b>
p. 53	<b>TUTA GALLEGGIANTE</b> <b>FLOATING SUIT</b>
p. 54	<b>TUTE PERSONALIZZATE</b> <b>CUSTOMIZED SUITS</b>
p. 56	<b>SCARPE FIA</b> <b>FIA SHOES</b>
p. 60	<b>SCARPE NAVIGATORE</b> <b>CO-DRIVER SHOES</b>
p. 61	<b>ACCESSORI NAVIGATORE</b> <b>CO-DRIVER ACCESSORIES</b>
p. 62	<b>GUANTI FIA</b> <b>FIA GLOVES</b>
p. 66	<b>SOTTOTUTA IGNIFUGO</b> <b>FIREPROOF UNDERWEAR</b>
p. 68	<b>CASCHI SUOMY</b> <b>SUOMY HELMETS</b>
p. 70	<b>CASCHI</b> <b>HELMETS</b>
p. 72	<b>SISTEMA HANS</b> <b>HANS DEVICE</b>
p. 73	<b>TUTE MECCANICO</b> <b>MECHANIC SUITS</b>
p. 76	<b>SCARPE MECCANICO</b> <b>MECHANIC SHOES</b>
p. 77	<b>GUANTI E ACCESSORI MECCANICO</b> <b>MECHANIC GLOVES AND ACCESSORIES</b>
p. 78	<b>LABORATORIO SEDILI</b> <b>SEAT LAB</b>
p. 80	<b>SEDILI</b> <b>SEATS</b>
p. 95	<b>ACCESSORI SEDILI</b> <b>SEATS ACCESSORIES</b>
p. 96	<b>ROLL BAR</b> <b>ROLL CAGES</b>
p. 104	<b>VOLANTI</b> <b>STEERING WHEELS</b>
p. 108	<b>IMPIANTI ESTINZIONE</b> <b>FIRE EXTINGUISHING SYSTEMS</b>
p. 112	<b>PEDANE E PEDALIERE</b> <b>FOOTRESTS AND PEDALS</b>
p. 113	<b>ACCESSORI</b> <b>ACCESSORIES</b>

# Caratteristiche delle tute alto di gamma

## Top of the range suits features

Nuovo design Sabelt per la spallina con bordo ricamato.  
*New Sabelt Design for the epaulettes with, embroidered pipings.*

Etichetta in Nomex.  
*Nomex label.*

Cuciture piatte anti sfregamento.  
*Flat seams to avoid scraping.*

Cintura riposizionata anteriormente al fine di ridurre lo spessore sui fianchi.  
*Belt sewn with flat seams and shortened at ends to reduce thickness at hips.*

Polsini in maglia costina aramidica con cuciture piatte.  
*Knitted aramidic fabric cuffs with flat seams.*

Cuciture strutturali in filo aramidico.  
*Structural seams made of aramidic thread.*

Interno collo in maglia.  
*Soft knitted inner collar.*

Giromanica in maglia elasticizzata multidirezionale.  
*Floating sleeves in stretch knitted interlock.*

Cerniera in metallo con bordo in kevlar.  
*Metallic zip, kevlar border.*

Copertura cerniera con chiusura velcro.  
*Overlap velcro fastened.*

Fascia elastica renale.  
*Lumbar stretch panel.*

Tasche applicate al fine di ridurre lo spessore.  
*Applied pockets to reduce thickness.*

Cuciture laterali spostate sul davanti per il massimo comfort.  
*Forward relocated side seams for increased comfort.*

Trapuntature a quadri 9.5 x 9.5cm.  
*Box quilting 9.5 x 9.5cm.*

# LABORATORIO TUTE SUIT LAB

Foto 1: **Resistenza alla combustione.** Come richiesto dallo standard Fia 8856-2000, ogni singolo strato di tessuto per le tute ignifughe è testato per verificarne la resistenza alla combustione secondo lo standard Iso 15025. L'obiettivo è verificare che la durata media di permanenza della fiamma sul tessuto, dopo l'applicazione per 10 s di una fiamma di gas propano di opportuna altezza, sia inferiore ai 2 s (par. 8.1 Standard FIA 8856-2000).

*Picture 1: Test for limited flame spread: as required by FIA 8856-2000 standard, each single fabric layer of fireproof suits is tested to verify burning resistance following ISO 15025 standards. The aim is to verify the average combustion time to be less than 2s, after the application for 10s of a propane gas flame par. 8.1 Standard FIA 8856-2000).*

Foto 2: **Trasmissione del calore.** Come richiesto dallo standard Fia 8856-2000, l'insieme degli strati dei tessuti per le tute ignifughe sono testati per determinarne la trasmissione del calore secondo lo standard Iso 9151. L'obiettivo è verificare che l'indice di trasferimento termico HTI24 (definito come tempo medio necessario per innalzare la temperatura di 24°C a seguito dell'effetto di un flusso termico di 80 kW/mq ottenuto con fiamma di gas propano) sia uguale o superiore a 11 s (par. 8.2 Standard FIA 8856-2000), le tute Sabelt hanno HTI24 largamente superiori al minimo richiesto.

*Picture 2: Heat Transmission: as required by FIA 8856-2000 standard, the total layers are tested to determine heat transmission following ISO 15025 standards. The aim is to verify HTI24 heat transmission rate (defined as the average time needed to increase temperature of 24°C / 75,2°F due to 80 kW/m2 obtained through propane gas flame) is equal or superior to 11s (par. 8.2 Standard FIA 8856-2000). All Sabelt fireproof overalls have successfully obtained HTI24.*

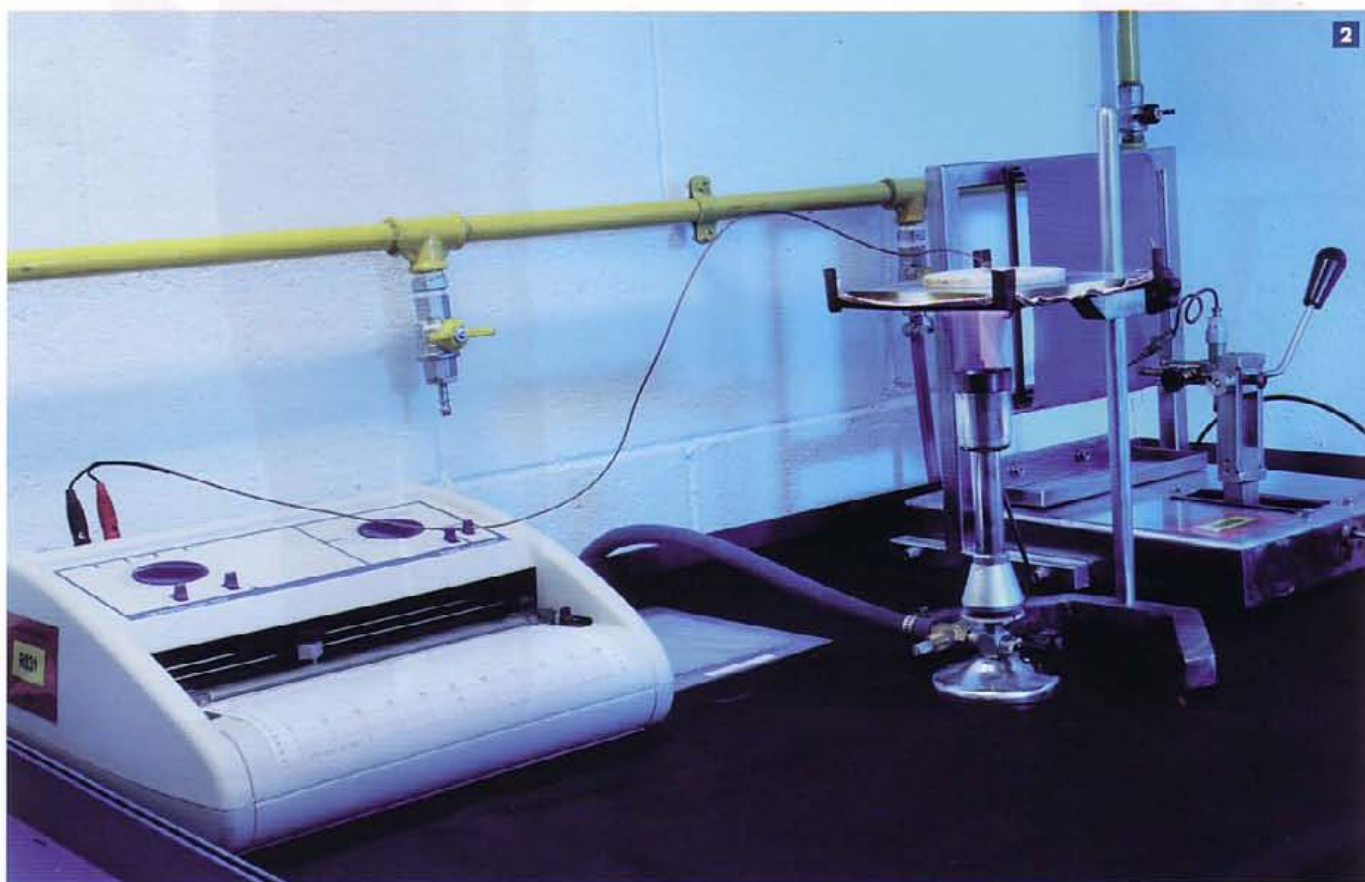

# TUTA DIAMOND DESIGN

## DIAMOND DESIGN SUIT

**Z141546** ROSSO/BIANCO  
RED/WHITE

Tuta tre strati  
Peso: 385gr/mq  
Strato esterno tessuto diamond lucido con trattamento s-dry  
Strati interni in maglia delta c - nido d'ape trattamento s-dry  
Nuove cuciture piatte  
Giro manica, fascia renale ed interno collo in maglia  
Spalline: design Sabelt Hans  
Trapuntatura colore su colore  
Omologata Fia 8856-2000  
taglie: 46-64

A richiesta colore e taglia per personalizzazione  
**Tuta consigliata per endurance e gare di rally e su circuito in ambienti caldi**

*Three layers*  
*Weight: 385gr/mq*  
*External layer: shiny diamond fabric s/dry treated*  
*Internal layers: Knitted textile - s-dry honey comb treated*  
*Floating sleeves, lumbar panel, inner collar in delta c knitted textile*  
*Straps: new Sabelt Hans design*  
*Quilting color on color*  
*Fia 8856-2000 homologated*  
*Size: from 46 to 64*  
*Customized suit on request.*  
*This suit is recommended for endurance race and hot climates rally or circuit events*



COLORI DISPONIBILI PER  
LA PERSONALIZZAZIONE  
COLOURS AVAILABLE  
FOR CUSTOMIZATION



**Z141555**  
GRIGIO SCURO/GRIGIO CHIARO  
DARK GREY/LIGHT GREY



**Z141536**  
BLU ROYAL/BIANCO  
ROYAL BLUE/WHITE



ARANCIONE  
ORANGE



VERDE "ASTON"  
"ASTON" GREEN



BLU NAVY  
NAVY BLUE



GRIGIO SCURO  
DARK GREY



# TUTA DIAMOND

## DIAMOND SUIT



**Z141530** BLU  
BLUE

Tuta tre strati  
Peso: 365 gr/mq  
Strato esterno tessuto diamond, costruzione tela semilucida  
Strati interni in maglia a nido d'ape, plus: leggerezza e traspirabilità  
Giro manica, fascia renale ed interno collo in maglia interlock  
Spallina: nuovo design Sabell  
Trapuntatura colore su colore e profili in contrasto (bianco)  
Omologata Fia 8856-2000  
Taglie: 46-64  
A richiesta colore e taglia per personalizzazione  
**Tuta consigliata per endurance e gare di rally e su circuito in ambienti caldi**

*Three layers. Weight: 365 gr/mq  
External layer: Diamond fabric  
Internal layers: honey comb knitted textile  
Floating sleeves, lumbar panel, inner collar in knitted interlock  
Strap: Sabell Design  
Quilting colour on colour and piping in contrast (white)  
Fia 8856-2000 homologated. Size: from 46 to 64  
Customized suit on request  
This suit is recommended for endurance race and hot climates rally or circuit events*



**Z141540** ROSSO  
RED



**Z141520** NERO  
BLACK



**Z141570** GIALLO  
YELLOW



**Z141550** GRIGIO  
GREY



Giro manica in interlock.  
Floating sleeves bellows in interlock.



Fascia renale in interlock.  
Lumbar stretch panel in interlock.

# TUTA TOP TECH 2

## TOP TECH 2 SUIT

**Z1419502** GRIGIO CHIARO  
LIGHT GREY

Tuta tre strati. Peso: 340 gr/mq  
**Strato esterno in tessuto lucido**  
 Giro manica, fascia renale ed interno collo in maglia interlock  
 Spallina: Hans Sabelt design  
 Trapuntatura colore su colore  
 Omologata Fia 8856-2000  
 Taglie: 46-64

*Three layers. Weight: 340 gr/mq*  
*External layer in shiny fabric*  
*Floating sleeves, inner collar in knitted interlock*  
*Strap: Hans Sabelt Design*  
*Quilting color on color*  
*Fia 8856-2000 homologated*  
*Size: from 46 to 64*  
*Customized suit on request*



**Z1419602** BIANCO  
WHITE



**Z1419302** BLU ROYAL  
ROYAL BLUE



**Z1419402** ROSSO  
RED



Giro manica in interlock.  
 Floating sleeves bellows in interlock.

COLORI DISPONIBILI PER LA PERSONALIZZAZIONE  
 COLOURS AVAILABLE FOR CUSTOMIZATION



NERO  
BLACK

# TUTA CUP

## CUP SUIT



**Z141452**  
NERO/GRIGIO LUCIDO  
BLACK/SHINY GREY



**Z141463** BLU ROYAL/BIANCO  
ROYAL BLUE/WHITE



Giro manica in interlock.  
Floating sleeves bellows in interlock.



Fascia renale in interlock.  
Interlock lumbar stretch panel.

**Z141464** ROSSO/BIANCO  
RED/WHITE

Stesso modello e caratteristiche della tuta Speedy 2 ma in versione bicolore con tessuto Satin nella parte inferiore e lucido di nomex sul busto.

*Same model and characteristics of Speedy 2 suit, but in two-colour version with satin fabric basis on legs and shiny nomex on chest.*



# TUTA SPEEDY2

## SPEEDY2 SUIT



**Z1414302** BLU ROYAL  
ROYAL BLUE



**Z1414502** GRIGIO  
GREY



**Z1414402** ROSSO  
RED

**Z1414202** NERO  
BLACK

Tuta tre strati. Peso: 380 gr/mq.  
Strato esterno in tessuto satin semi lucido.  
Giro manica, fascia renale ed interno collo in maglia interlock.  
Spallina: nuovo design Sabelt. Trapuntatura tono su tono.  
Omologata Fia 8856-2000. Taglie: 46-64.  
A richiesta taglie personalizzate.

*Three layers suit. Weight: 380 gr/m<sup>2</sup>  
External layer in satin nomex fabric.  
Floating sleeves bellows, lumbar panel and inner collar  
in knitted interlock  
Epaulettes embroidered with new Sabelt design.  
Quilting and piping in contrast. FIA 8856-2000 homologated.  
Sizes: 46-64. Upon request customized sizes.*



Giro manica in interlock.  
Floating sleeves bellows in interlock.



Fascia renale in interlock.  
Interlock lumbar stretch panel.



# TUTA DRIVER PLUS2

## DRIVER PLUS2 SUIT

**Z141236P2** BLU/BIANCO  
ROYAL BLUE/WHITE

Spallina Sabelt design  
Trapuntatura a quadri colore bianco  
Stesso modello e caratteristiche della tuta Driver Plus 2  
ma in versione bicolore

*New Sabelt design strap*  
*Square quilting in white*  
*Same model of Driver Plus 2 suit in bicolor version*



**Z141226P2** NERO/BIANCO  
BLACK/WHITE



**Z141246P2** ROSSO/BIANCO  
RED/WHITE



**Z141220P2** NERO  
BLACK



**Z141230P2** BLU  
BLUE

**Z141240P2** ROSSO  
RED

Tuta tre strati  
Peso: 380 gr/mq  
Strato esterno in soffice tessuto spina  
giro manica in maglia  
Trapuntatura a quadri e profili di sbieco in contrasto  
Nuova spallina Sabelt design  
omologata Fia 8856-2000  
Taglie: 46-64 (66 su richiesta)  
A richiesta colore e taglia personalizzata

*Three layers  
Weight: 380 gr/mq  
External layer in soft nomex twill  
Floating sleeves  
Square quilting and Piping in contrast  
New sabelt design strap  
Fia 8856 2000 Homologated  
Size: from 46 to 64 (66 on request)  
Customized suit on request*



COLORI DISPONIBILI PER LA PERSONALIZZAZIONE  
COLOURS AVAILABLE FOR CUSTOMIZATION



GRIGIO  
GREY



GIALLO  
YELLOW



VERDE  
GREEN



AZZURRO  
LIGHT BLUE

# TUTA CREATION CREATION SUIT

**Z141122** NERO/BLACK

**Tre strati.**

Peso: 380 gr/mq  
Strato esterno in soffice tessuto spina  
Maniche semi-flostanti con soffietto in maglia sul retro  
Trapuntature verticali in contrasto  
Profili in contrasto su cintura e tasche  
Nuova spallina Sabelt design  
Omologata Fia 8856-2000  
Taglie: 46 a 64. Non personalizzabile

*Three layers*

*Weight: 380 gr/mq  
External layer in soft nomex twill  
Half floating sleeves on the rear side  
with stretch knitted textile  
Quilting in contrast  
Piping in contrast on belt and pocket  
New sabelt design strap  
Fia 8856-2000 Homologated  
Size: from 46 to 64  
No Customizable suit*



**Z141133** BLU/BLUE



**Z141155** GRIGIO/GREY



**Z141144** ROSSO/RED

Su richiesta disponibile in versione monostrato

*On request available with one layer only*



Soffietto posteriore in maglia.  
*Stretch knitted rear bellows.*



# TUTA GALLEGGIANTE: FLOATECH FLOATING SUIT: FLOATECH

Sempre sensibile al discorso della sicurezza e interessata alla continua ricerca di nuovi materiali Sabelt, in collaborazione con gli esperti del mondo della motonautica, ha realizzato la tuta galleggiante che sostituisce i salvagenti obbligatori attualmente utilizzati dai piloti di questa disciplina. Il risultato è una tuta comoda, leggera, traspirante e termo-regolante approvata dalla UIM F1. Ogni modello di tuta della vasta gamma Sabelt può diventare galleggiante grazie al nuovo e rivoluzionario materiale a struttura cellulare che garantisce eccezionali prestazioni grazie alle sue principali caratteristiche fisiche: capacità di galleggiamento, isolamento termico, impermeabilità, leggerezza.



Conforme regolamentazioni UIM.  
Meets UIM specifications.

Uno strato esterno di nomex e strati di Sablite cuciti all'interno della tuta

*Strongly focused in safety and new material research, Sabelt, in collaboration with powerboat experts, has realized an overall that replaces the compulsory life jackets currently used by powerboat drivers. The result is a comfortable, light, breathable and thermo-regulating overall line approved by UIM F1.*

*Any of Sabelt suit model can become a floating overall thanks to the revolutionary new cellular material that delivers outstanding performance thanks to its remarkable combination of waterproof, lightweight and buoyancy characteristics, while offering excellent thermal insulation.*

*One external layer of nomex suit with uneven disposal of floatable Sablite sewed inside the overall.*

Il progetto di realizzare una tuta galleggiante nasce dalla conoscenza di Sablite, un nuovo materiale con incredibili proprietà di galleggiamento che viene disposto in una zona specifica tra gli strati della tuta.

L'utilizzo di questo materiale duttile permette un notevole comfort in confronto al solito giubbotto salvagente.

Sabelt ha effettuato diversi test sia per la messa a punto della disposizione del materiale galleggiante all'interno della tuta che per raggiungere i risultati prefissati: il galleggiamento appropriato, la rotazione del pilota in caso di urto frontale e la garanzia che la testa del pilota rimanga sempre sopra la superficie dell'acqua.

*Floatech project comes out from the use of Sablite, a new material characterized by amazing floating properties, which has been displaced within topic areas between the layers of the suit. Using flexible fabric allows an outstanding comfort compared to usual life jackets.*

*The result of several test carried out by Sabelt is a layout where the displacing of the floating material has been studied in order to make the pilot body to rotate in case of frontal fall, keeping, in this way, the face over the water surface.*

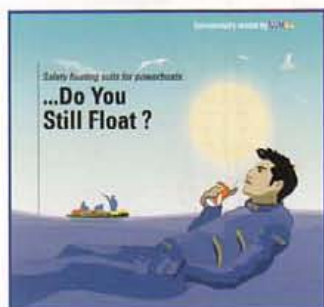

Sponsor del Class 1 World Powerboat Championship team del Qatar.  
Sponsor of Class 1 World Powerboat Championship Qatar team.



Da più di 20 anni Sabelt fornisce le cinture da competizione per la motonautica ed è la prima azienda a realizzare tute galleggianti per i piloti di questa disciplina.

*Sabelt has been supplying harnesses to Powerboat competitions for about 20 years and it is the first company to realise floating overalls for powerboat drivers.*



RACING RACING



# TUTE PERSONALIZZATE CUSTOMIZED SUITS

TABELLA MISURE STANDARD STANDARD SIZES CHART

TAGLIA SIZES	TORACE CHEST	VITA WAIST	BACINO HIPS	PESO WEIGHT	ALTEZZA HEIGHT
46	85-88	77-80	89-92	48-54	165-166
48	89-92	81-84	93-96	54-60	167-169
50	93-96	85-88	97-100	60-66	170-172
52	97-100	89-92	101-104	66-72	173-175
54	101-104	93-96	105-108	72-78	176-179
56	105-108	97-100	109-112	78-84	180-184
58	109-112	101-104	113-116	84-90	185-187
60	113-116	104-108	117-120	90-96	188-190
62	117-120	109-112	121-124	96-102	191-193
64	121-124	113-115	125-128	102-108	194-196
66	125-128	116-119	128-132	108-114	197-199

Le misure sono espresse in cm e si riferiscono al corpo e non alla tuta. *Sizes listed are in cm and are for body measurements, not of the suit.*

Nome pilota <i>Driver's name</i>	
Statura <i>Height</i>	Cm Inch
Peso <i>Weight</i>	Kg Lbs
Taglia abituale per abbigliamento sportivo/ignifugo <i>Usual size in fireproof clothing</i>	
Vestibilità desiderata Morbida Attillata <i>Desired fitting: Loose-fitting Close-fitting</i>	M A L C
<b>1</b> Circonferenza collo <i>Neck circumference</i>	
<b>2</b> Largh. spalle: da una testa dell'omero all'altra aderendo alla schiena. <i>Shoulder breadth (from points of shoulders bones across back)</i>	
<b>3</b> Circonferenza torace <i>Chest circumference</i>	
<b>4</b> Circonferenza vita <i>Waist circumference</i>	
<b>5</b> Circonferenza bacino: all'altezza dei glutei nel punto più largo <i>Hip circumference</i>	
<b>6</b> Lungh. manica: dalla testa dell'omero al polso a braccio piegato <i>Sleeve length from point of shoulder bone to wrist (arm bent)</i>	
<b>7</b> Circonferenza coscia: nel punto più largo <i>Thigh circumference</i>	
<b>8</b> Lungh. entrogamba: dall'inguine alla lunghezza desiderata <i>Desired length from top of inside leg to bottom of trousers.</i>	
<b>9</b> Lungh. tot. tuta: dalla base laterale del collo alla lunghezza desiderata <i>Total overall length (from neck to bottom of trousers)</i>	
<b>10</b> Lungh. busto posteriore: dalla base posteriore del collo alla vita <i>Length from neck to waist (back)</i>	
<b>11</b> Lungh. gamba: dalla vita al fondo della tuta. <i>Outside leg length from waist to bottom of trousers.</i>	
<b>12</b> Lungh. tronco anteriore: dalla base anteriore del collo all'inguine <i>Body length from collar bone to top of inside leg (front)</i>	
<b>13</b> Lungh. busto anteriore: dalla base del laterale del collo a vita <i>Body length from inside shoulder (front) to waist</i>	
<b>14</b> Lungh. cavallo: da vita anteriore a vita posteriore passando per l'inguine <i>Crotch length from front waist through top of inside leg to back waist</i>	
<b>15</b> Lungh. cavallo tot: dalla base posteriore del collo alla base anteriore del collo <i>Crotch length from front collar bone through top of inside leg to back neck</i>	

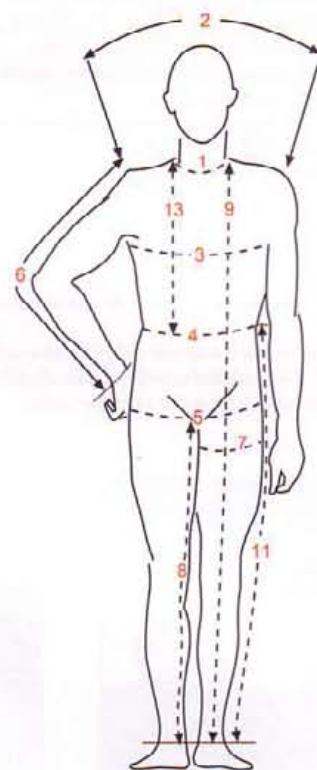

**CARATTERI STANDARD PER RICAMI STANDARD FONTS FOR EMBROIDERING**

*A B C D E F G H*

*a b c d e f g h*

Carattere **B** altezza consigliata da cm 0,89 a 10,16  
*B character suggested height from cm 0,89 to 10,16*

**A B C D E F G H**

**abcdefgh**

Carattere **D** altezza consigliata da cm 0,76 a 5,72  
*D character suggested height from cm 0,76 to 5,72*

RICAMO SULLA CINTURA  
 EMBROIDERY ON BELT

Si  
 Yes

No  
 No

COLORE FILO  
 THREAD COLOUR

NOME  
 NAME

BLOOD GROUP  
 GRUPPO SANGUIGNO

FLAG  
 BANDIERA

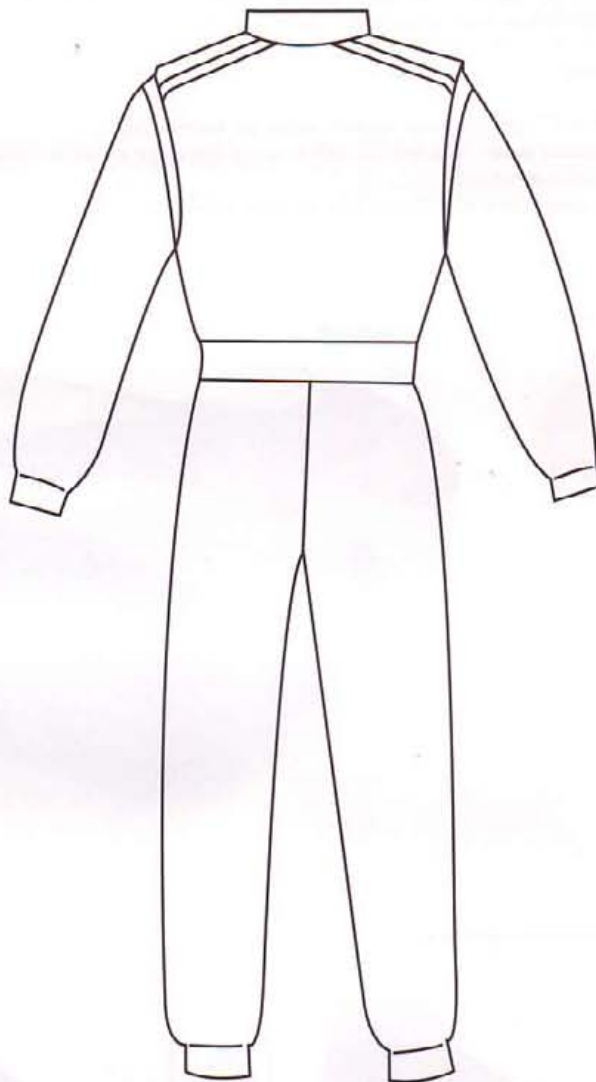
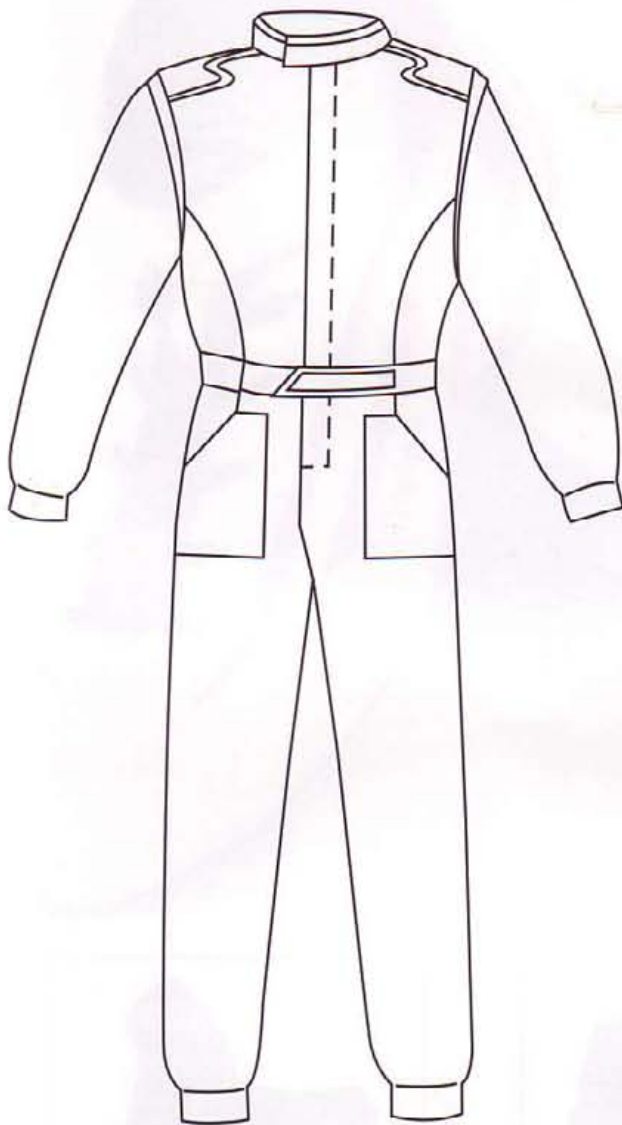

**TASCA NAVIGATORE  
 CO-DRIVER POCKET**

Su ordinazione è possibile applicare la tasca navigatore su tutti i modelli della gamma tute Sabelt.

*On order is possible to apply the co-driver pocket on every model of Sabelt suits range.*



**TASCA PORTACELLULARE  
 MOBILE-PHONE POCKET**

Su ordinazione è possibile applicare la tasca portacellulare su tutti i modelli della gamma tute Sabelt.

*On order is possible to apply the mobile-phone pocket on every model of Sabelt suits range.*



Rilevare le misure utilizzando un metro morbido, aderendo perfettamente al corpo. Tutte le circonferenze vanno rilevate nel punto più esteso  
*Take all measurements using a soft tape measure, following the lines of the body, and all circumferences are to be measured at the widest point. Wearing only underwear.*

# SCARPE LIGHT - mid

## LIGHT SHOES - mid

**Z131340** BIANCO/ROSSO  
WHITE/RED

Scarpa "LIGHT": novità tecniche sia per quanto riguarda i materiali utilizzati che per il design. Suola ultra leggera con design digit per una massima sensibilità sui pedali. La tomaia è particolare, infatti è prodotta con lo stesso tessuto nomex lucido che ha reso famose le tute Sabelt in combinazione con morbida pelle di cammello. Disponibile in versione alta o mid, taglie dalla 36 alla 48. La versione 2006 del modello MID è stata modificata secondo le nuove regolamentazioni FIA: parte posteriore non tagliata e aggiunta della chiusura velcro sulla caviglia.

*"LIGHT" shoe: new technology with cutting-edge materials and innovative design. Ultra-light sole, with its special digit design guarantees extreme driving responsiveness.*

*The vamp is particular: Nomex fabric has made Sabelt racing suits famous and now appears in footwear paired with camel leather.*

*Available in high and mid version, sizes from 36 to 48.*

*MID 2006 version has been up-dated to comply with new FIA regulations: no cut out at the rear, ankle velcro fastening.*

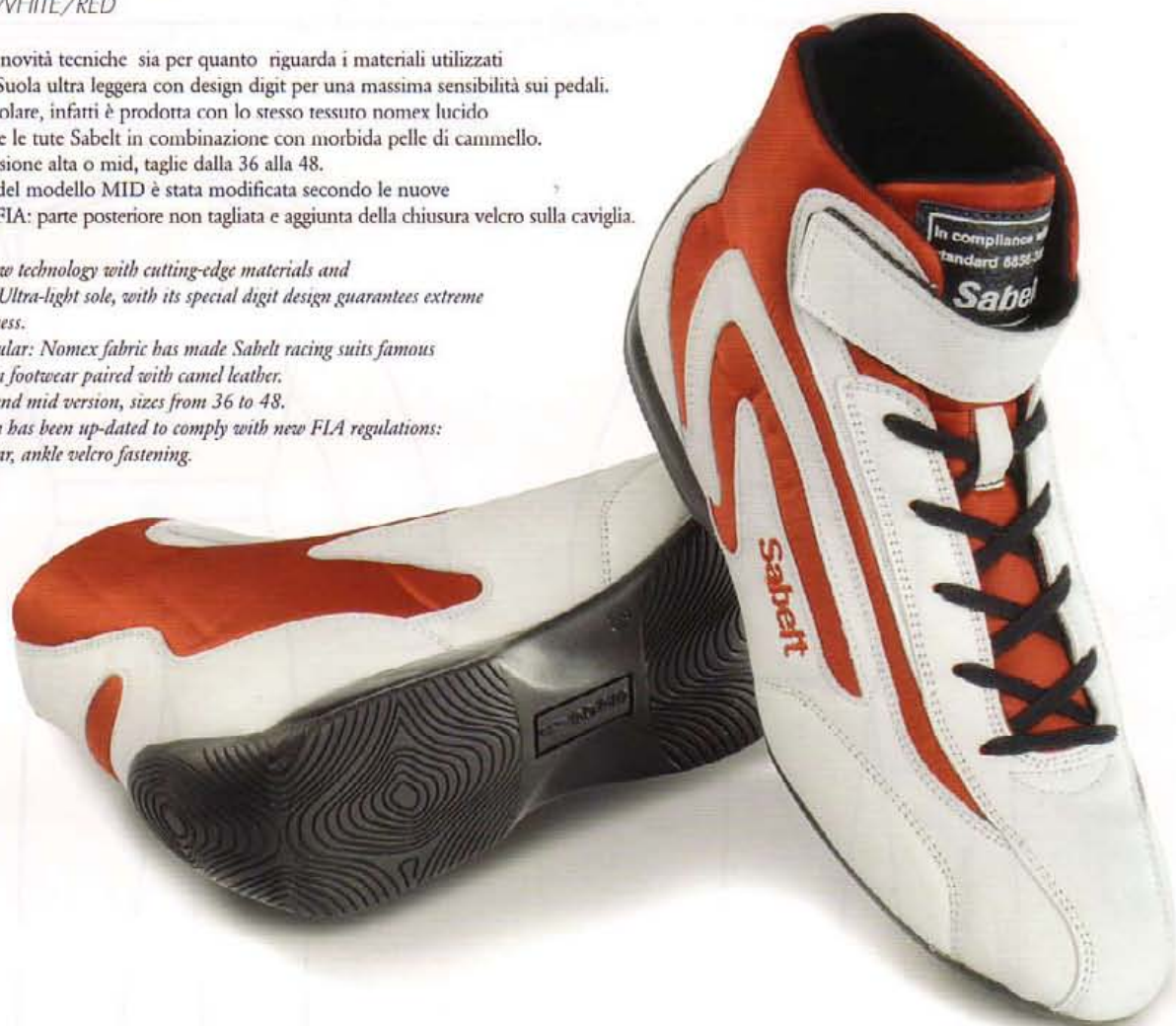

**Z131344** ROSSO  
RED



**Z131311** BLU  
BLUE



**Z131322** NERO  
BLACK



**Z131320** BIANCO/NERO  
WHITE/BLACK



**Z131310** BIANCO/BLU  
WHITE/BLUE



**Z131370** BIANCO/GIALLO  
WHITE/YELLOW

# SCARPE LIGHT - high

## LIGHT SHOES - high

**Z131410M** BIANCO/BLU  
WHITE/BLUE

La versione alta 2006 è stata modificata in rispetto delle nuove normative FIA con l'aggiunta delle due chiusure in velcro.

*High version up-dated for 2006 by adding velcro fastenings complying with new FIA regulation.*



**Z131420M** BIANCO/NERO  
WHITE/BLACK



**Z131440M** BIANCO/ROSSO  
WHITE/RED



**Z131444M** ROSSO  
RED



**Z131422M** NERO  
BLACK



**Z131411M** BLU  
BLUE

# SCARPE STREET - mid

## STREET SHOES - mid

**Z131110M** BLU/NERO  
BLUE/BLACK

Design innovativo e grintoso, stile tipico del made in Italy.  
Le due versioni, media e alta, sono entrambe conformi alle normative FIA 8856-2000.

Tomaia in pelle scamosciata, la suola è composta da una miscela leggera e, con lo speciale design "digit", assicura grande sensibilità e grip sui pedali.

Taglie dalla 36 to 48.

La versione 2006 del modello MID è stata modificata secondo le nuove regolamentazioni FIA: parte posteriore non tagliata, chiusura velcro sulla caviglia.



*Determined, innovative design, typical Made in Italy style.*

*The high version and the mid one, are both complying with FIA regulations 8856-2000.*

*Reserched look perfectly match with improved comfort and practical use.*

*Suede vamp, the sole is a light mixture material with a special digit design to improve grip.*

*Sizes from 36 to 48.*

*MID 2006 version up-dated to comply with new FIA regulations: no cut out at the rear, ankle velcro fastening.*



**Z131120M** NERO  
BLACK



**Z131150M** GRIGIO/NERO  
GREY/BLACK



**Z131140M** ROSSO/NERO  
RED/BLACK



**Z131170M** GIALLO/NERO  
YELLOW/BLACK

# SCARPE STREET - high

## STREET SHOES - high

**Z131270** GIALLO/NERO  
YELLOW/BLACK

La versione alta 2006 è stata modificata in rispetto delle nuove normative FIA con l'aggiunta delle due chiusure in velcro.

*High version up-dated for 2006 by adding velcro fastenings complying with new FIA regulation.*

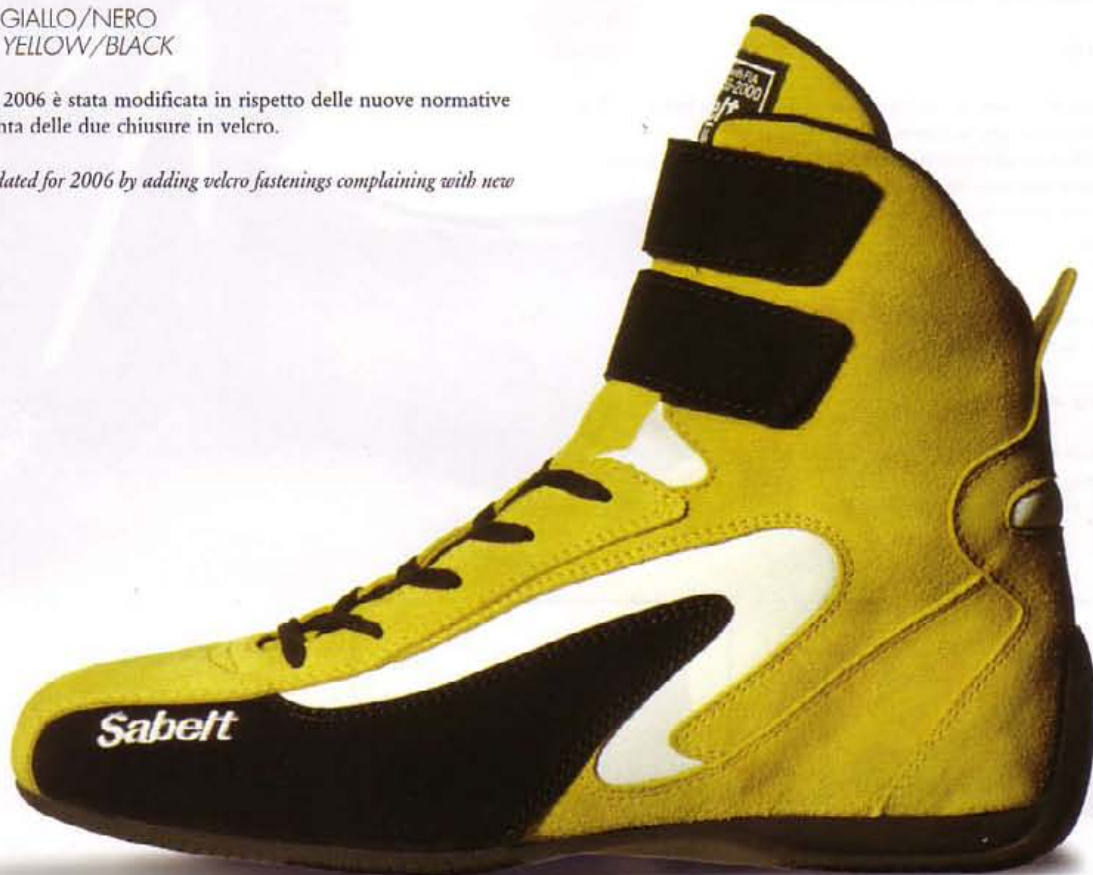

**Z131250** GRIGIO/NERO  
GREY/BLACK



**Z131220** NERO  
BLACK



**Z131240** ROSSO/NERO  
RED/BLACK



**Z131210** BLU/NERO  
BLUE/BLACK

# NAVIGATORE CO-DRIVER

## Scarpe Shoes

### STREET MECHA (OMOLOGATE FIA) STREET MECHA (FIA APPROVED)

**Z131610** BLU-NERO / BLUE-BLACK

Nuova scarpa in camoscio con inserti in morbida pelle bianca al fine di una facilitazione nei movimenti  
Interno in Nomex, chiusura con Velcro per una calzata più sicura  
Suola alta con uno speciale design per un grip migliore e per facilitare i piegamenti  
Estrema leggerezza. Omologata FIA 8856-2000  
Taglie 37-48

*Three colour suede design, with soft white leather inserts to allow easy movement.*

*Nomex lining, velcro strap for secure fit*

*Wide sole, with special grip design allowing easy bending*

*Lightweight. FIA homologated 8856-2000  
Sizes 37-48*



**Z131620** NERO / BLACK



**Z131640** ROSSO-NERO  
RED-BLACK



### PADDOCK (OMOLOGATE FIA) PADDOCK (FIA APPROVED)

**Z130540** ROSSO / RED

Scarpa media in pelle scamosciata, fodera ignifuga e suola idrorepellente, oleorepellente ed antiscivolo.

Omologata FIA.

Studiata per navigatori rally e meccanici.  
Taglie disponibili: dalla 36 alla 46.

*Mid shoe in suede, fireproof lining, water-repellent and anti-slip sole.  
Suitable for rally co-drivers and mechanics.  
FIA approved. Sizes: 36 to 46.*





**Z240900** BORSA NAVIGATORE  
CO DRIVER BA

Pratica borsa utilizzabile anche nel tempo libero come porta documenti o porta computer. Tasca interna porta cellulare.

*Practical briefcase and computer holder to be used also in spare-time. Inner mobile phone pocket.*



**Z240500** LAMPADA LEGGINOTE  
MAPLIGH

Lunghezza 41,5 cm.  
Lampadina rossa.

*Length 41,5 cm.  
Red light bulb.*

**Z240600** QUADERNO  
NOTEBOOK

Misura 22 x 17,5 cm.

*Size 22 x 17,5 cm.*

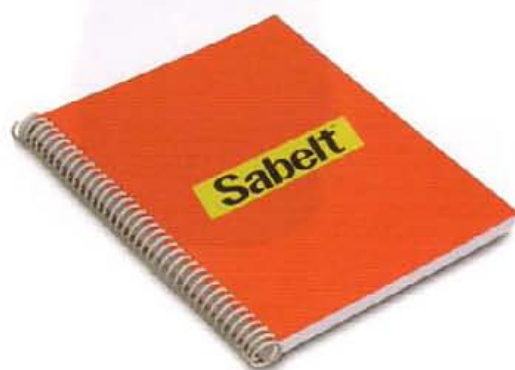

**Z121122..NAV** NERO/BLACK

Disponibile in versione per navigatore. Taglie dalla 8 alla 12.

*Co-driver version available. Sizes from 8 to 12.*

# GUANTI TRACK TRACK GLOVES

**Z121320** NERO/BIANCO  
BLACK/WHITE

Conforme alle regolamentazioni FIA 2000,  
cuciture esterne, palmo in pelle Digit.  
Adatto all'uso su pista.  
Nuovo design Sabell.  
Taglie: 8 - 13.

*FIA 2000 standard approved, external seams,  
Digit leather on palm.  
For track using.  
New Sabell design.  
Sizes: 8 - 13.*



**Z121340** ROSSO/BIANCO  
RED/WHITE



**Z121310** BLU/BIANCO  
BLUE/WHITE

## TAGLIE GUANTI GLOVES SIZE



Facendo il pugno, misurare attorno al punto più largo della mano oltre le nocchie, escludendo il pollice.

*Close your fist, measure around the widest part of your hand, thumb excluded.*

17,5 - 19,5 cm	19,5 - 21,5 cm	21,5 - 23,5 cm	23,5 - 25,5 cm	+25,5 cm
08 XS	09 S	10 M	11 L	12 XL

# GUANTI CHRONO

## CHRONO GLOVES



**Z121440** ROSSO/NERO/BIANCO  
RED/BLACK/WHITE



**Z121410** BLU/NERO/BIANCO  
BLUE/BLACK/WHITE



**Z121420** NERO/BIANCO  
BLACK/WHITE

Conforme alle regolamentazioni FIA 2000,  
cuciture esterne, palmo in camoscio.  
Adatto per il rally.  
Nuovo design Sabelt.  
Taglie: 8 - 13.

*FIA 2000 standard approved, external seams, suede on palm.  
For rally competitions.  
New Sabelt design.  
Sizes: 8 - 13.*



# GUANTI START

## START GLOVES



**Z121510** BLU ROYAL  
ROYAL BLUE

Guanto in maglia con rinforzi in pelle scamosciata sul palmo  
Omologazione Fia 8856-2000  
Cuciture interne  
Cuciture esterne sul palmo per migliorare il comfort  
Taglie: 8 a 13.

*Gloves in knitted textile with suede reinforcement on palm.  
Fia 8856-2000 homologated  
Internal seams  
External seams on palm to improve comfort  
Size: 8 to 13*



**Z121540** ROSSO  
RED



**Z121520** NERO  
BLACK

# GUANTI PRIMO

## PRIMO GLOVES



**Z121140** ROSSO/GRIGIO  
RED/GREY



**Z121110** BLU/GRIGIO  
BLUE/GREY



**Z121120** NERO/GRIGIO  
BLACK/GREY

Guanto in pelle scamosciata privo di rinforzi,  
manicotto corto privo di chiusura.  
Taglie: 8 a 13.

*In suede without reinforcements, short sleeve  
without fastening.  
Sizes: 8 to 13.*



# ABBIGLIAMENTO SOTTOTUTA UNDERWEAR

Sottotuta in Nomex *Nomex Underwear*



## MAGLIA MANICHE LUNGHE COLLO LUPETTO LONG SLEEVE WITH HIGH COLLAR SWEATER

**Z150110** BLU/BLUE  
**Z150140** ROSSO/RED  
**Z150160** ECRU/ECRU

Realizzata in maglia nomex e conforme alle norme 8856-2000.  
Taglie: da S a XXL.

*In nomex knitwear conforms to 8856-2000 standard.  
Sizes: S to XXL.*



## PANTALONI LUNGHI LONG TROUSERS

**Z150260** ECRU/ECRU

Realizzati in maglia nomex, omologati Fia.  
Taglie disponibili: da S a XXL.

*In nomex knitwear conforms to Fia standard.  
Sizes: S to XXL.*

## CALZE IGNIFUGHE LUNGHE LONG FIREPROOF SOCKS

**Z150460** ECRU/ECRU

Omologate Fia. Taglie: da S a XL.

*To Fia standard. Sizes: S to XL.*



## SOTTOCASCO UNDER HELMET

**Z150360OC** ECRU/ECRU

Apertura oculare, maglia nomex,  
cuciture piatte, omologati Fia, Taglia unica.

*Eye opening, nomex knitwear, flat seams,  
Fia approved. One size.*



## SOTTOCASCO UNDER HELMET

**Z150360** ECRU/ECRU  
**Z150340** ROSSO/RED  
**Z150310** BLU/BLUE  
**Z150320** NERO/BLACK

Apertura normale, maglia nomex.  
Cuciture piatte. Omologati Fia.  
Taglia unica.

*Normal opening, nomex knitwear,  
flat seams, Fia approved. One size.*



# Sottotuta in DeltaC *DeltaC Underwear*

Nuovi sottotuta realizzati in DeltaC: materiale di nuova generazione soffice al tatto, estremamente traspirante approvato dalle regolamentazioni FIA 8856-2000.

*New DeltaC Underwear: new generation material soft touch, highly perspirant, FIA 8856-2000 standards approved.*



## **LUPETTO MANICA LUNGA LONG SLEEVED ROLL NECK TOP**

**Z150160D** BIANCO NATURALE/NATURAL WHITE  
Realizzata in DeltaC, omologata FIA. Taglie disponibili: da S a XXL.

*In DeltaC knitwear FIA standard approved. Sizes: S to XXL.*



## **PANTALONI LUNGHI LONG TROUSERS**

**Z150260D** BIANCO NATURALE/NATURAL WHITE  
Realizzati in DeltaC, omologati FIA. Taglie disponibili: da S a XXL.

*In DeltaC knitwear FIA standard approved. Sizes: S to XXL.*



## **SOTTOCASCO APERTURA OCULARE OPEN FACE BALACLAVA**

**Z150360DOC** BIANCO NATURALE/NATURAL WHITE

Realizzato in DeltaC, omologato FIA.  
Cuciture piatte. Taglia Unica.

*In DeltaC knitwear Fia standard approved.  
Flat seams. One Size.*



## **SOTTOCASCO APERTURA NORMALE OPEN FACE BALACLAVA**

**Z150360D** BIANCO NATURALE/NATURAL WHITE

Realizzato in DeltaC, omologato FIA.  
Cuciture piatte. Taglia Unica.

*In DeltaC knitwear FIA standard approved.  
Flat seams. One Size.*

# CAR RACING

Suomy's ambitions exceed the boundaries of two wheel Motorsports. The all-new F1 and F1-K (non-fire retardant for karting) formula helmet sets a new standard for racing helmets in the very demanding Auto Racing market. While new to the four-wheel racing community, the all new F1 and F1-K helmets have been heralded as the new standard in open wheel competition.

Among the F1 outstanding features is this helmets incredibly lightweight. At just 3 lbs the F1 is the lightest non-carbon fiber helmet on the market. This helmet remains stable and firmly placed on the racers head even at speeds in excess of 200 MPH! Unique antennae ram air intakes can be rotated to an exhaust position, providing adjustability to internal airflow.

## Technical Specs

- Sur-Lock
- Air-Wave
- S.E.C.
- Two shell sizes
- Special sound-absorbing polymers
- Inner lining fire-proof (F1 only)
- Neck protection
- Competition-style D-ring closure, with button to fix strap (Suomy patented)
- Scratch-proof and antifog visor (3mm thickness)
- Upper Venturi-effect "Antennae" style intake / exhaust vents

## CARATTERISTICHE TECNICHE

- Sur-Lock
- Air-Wave
- S.E.C.
- Calotta esterna in due misure
- Speciali polimeri fonoassorbenti
- Interno in materiale ignifugo (solo F1)
- Protezione cervicale
- Cinturino con chiusura D-Ring, tipo racing e bottone fissa cinturino (brevetto Suomy)
- Visiera antigraffio e antifog (spessore 3mm)
- Ventilazione superiore regolabile

## Spare Parts

### ORIGINAL VISORS VISIERE ORIGINALI

Clear Trasparente	KAF1VT
Mid tint Fumè chiaro	KAF1VF
Full tint Fumè scuro	KAF1VS
Iridium	KAF1VI
Iridium	KAF1VI
Clear water-repellent Trasparente idrofobica	KAF1VC
Tint water-repellent Fumè idrofobica	KAF1VD

### TEAR-OFF LENS (SETS OF 5) KIT LENTI A STRAPPO (GRUPPI DI 5)

Clear Trasparente	KASSF1
----------------------	--------

### FULL PIVOT KIT KIT COMPETO MECCANISMI

Blue / Gold Blu / Oro	KAF1CI
--------------------------	--------

### TOP VENTILATION VENTILAZIONE SUPERIORE

White Bianco	KAF101
-----------------	--------

### SPOILER SPOILER

White Bianco	KAF1T1
-----------------	--------

## Homologations

### ISO 9001: 2000 Certification

- Snell SA 2005
- Omologato in conformità alle normative Snell SA 2005
- Hans System FLA standard 8858 - 2002
- Hans System FLA standard 8858 - 2002



HANS SYSTEM



sizes

XS	S	M	L	XL	XXL
53/54	55/56	57/58	59 / 60	61/62	63/64
6-1/2'	6-3/4'	7'	7-1/4'	7-1/2'	7-3/4'
6-5/8'	6-7/8'	7-1/8'	7-3/8'	7-5/8'	7-7/8'



# Racing

## F1

**Z220600** BIANCO F1  
WHITE F1

Taglie: da XS a XXL  
versione ignifuga.

Sizes: XS to XXL.  
fire-proof version



# Karting

## K1

**Z220700** BIANCO KARTING  
WHITE KARTING

Taglie: da XS a XXL  
versione kart.

Sizes: XS to XXL.  
kart version



**Sabelt**

is Worldwide Distributor for



# CASCHI JET

## JET HELMETS



**Z220200** GRIGIO  
GREY

### TROPHY

Casco jet completo di interfono Peltor, cuffie e microfono.  
Interno rivestito in maglina ignifuga.  
Chiusura con laccetto.  
Fornito completo di visiera in tinta con il casco.  
Omologato BSI 6658 A/FR  
Colore grigio.  
Taglie: da S a XL.

*Jet helmet complete with Peltor intercom and noise reduction earcups, internal microphone.  
Inside fireproof knitwear lining.  
D-ring fastening.  
BSI 6658 A/FR approved.  
Grey colour.  
Sizes: S to XL.*

**Z220400** GRIGIO  
GREY

Casco jet con interno rivestito in maglina ignifuga.  
Chiusura con laccetto.  
Fornito completo di visiera in tinta con il casco.  
Omologato BSI 6658 A/FR  
Colore grigio.  
Taglie: da S a XL.

*Jet helmet, inside fireproof knitwear lining.  
D-ring fastening.  
BSI 6658 A/FR approved.  
Grey colour.  
Sizes: S to XL.*



**Z220010**

Centralina Peltor.  
FMT110 control box.



**Z220008**

Frontino lungo.  
Long grey peak.

# CASCHI JET HANS® HANS® JET HELMETS



**Z220300** GRIGIO  
GREY

Casco Trophy con predisposizione Hans®.  
Omologato BSI 6658 A/FR.  
Taglie: da S a XL.

*Trophy helmet with Hans® Clips.  
BSI 6658 A/FR approved.  
Sizes: S to XL.*



**Z220500** GRIGIO  
GREY

Casco Jet con predisposizione Hans®.  
Omologato BSI 6658 A/FR.  
Taglie: da S a XL.

*Jet helmet with Hans® clips.  
BSI 6658 A/FR approved.  
Sizes: S to XL.*



Viti Hans®.  
Hans® clip.

## TAGLIE CASCHI HELMET SIZES

Misurare la circonferenza testa sopra le orecchie. Prendere le misure in cm.  
Measure head circumference above the ears. Measure in cm.

55 cm 56 cm 57 cm 58 cm 59 cm 60 cm 61 cm 62 cm

**S**

**M**

**L**

**XL**



# SISTEMA HANS® HANS® DEVICE

## ZB36HANSP

Sistema HANS® PRO sviluppato da Stand 21.

Peso 520 - 600 gr

Realizzato in fibra di carbonio.

Fornito con Padding standard.

*HANS® PRO device developed by Stand 21.*

*Weight 520 - 600 gr*

*Made in carbon fiber.*

*Supplied with standard Padding.*



4 INCLINAZIONI DISPONIBILI AVAILABLE IN 4 INCLINATIONS

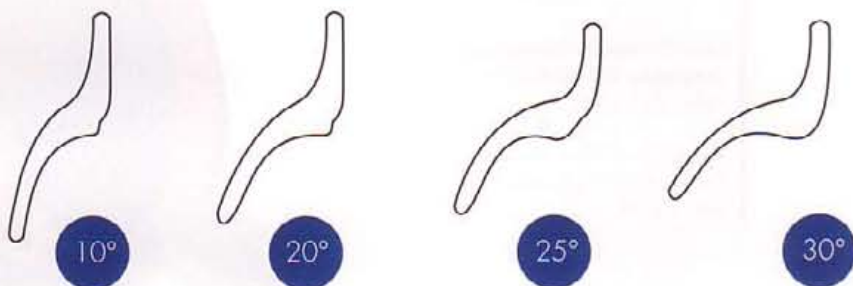

**475040H** ROSSO/RED  
**475020H** NERO/BLACK

Cuscinetti Pad professionali in gel sviluppati per il sistema HANS®

*Professional gel Padding developed for HANS® device.*

- 10° ideale per una seduta in avanti (utilizzo rally)  
*ideal for forward seating (rally use)*
- 20° seduta diritta, utilizzo in berline GT  
*straight seating, use in GT saloon cars*
- 25° adatto per i giovani piloti e le donne  
*ideal for young and women drivers*
- 30° seduta semi-allungata, ideale per monoposto e prototipi  
*ideal for single-seaters and prototype cars*

DISPONIBILE NELLE SEGUENTI TAGLIE AVAILABLE IN THIS SIZE

	10°	20°	25°	30°
S		●	●	
M	●	●		●
L		●		●

# TUTE MECCANICO MECHANICS SUITS



## TUTA PROF-X Z1405101 BLU/BLUE

Tessuto poliestere/cotone peso 210 gr/m<sup>2</sup>  
Rete igienica interna libera altezza torace  
per il massimo comfort.  
Mezza luna di maglia sulla schiena  
a scomparsa (coperta da tessuto).  
Tasca sulle ginocchia  
con imbottitura protettiva.  
Tasca porta attrezzi sulla gamba destra.  
Tasca interna dimensioni 13x13 cm.  
Polsini in maglia.  
Chiusura velcro alla caviglia.  
Profili e trapuntatura a contrasto.  
Taglie da S a XXL.

*Polyester/cotton 210 gr/m<sup>2</sup> fabric suit.  
It features a hygienic netting lining  
at chest level to offer maximum comfort.  
Stretch fabric covered lumbar panel.  
Protective padding on knees.  
Tools pocket on right leg.  
Internal pocket 13x13 cm.  
Knitted cuffs.  
Velcro ankle fastening.  
Quilting and piping in contrast.  
Sizes from S to XXL.*



Tasca interna.  
Internal pocket.

Su richiesta disponibile in versione ignifuga monostrato  
On request available fireproof with one layer only version



Z1405401 ROSSO/RED



Fascia renale in maglia.  
Lumbar stretch panel.



Tasca porta oggetti.  
Pocket.



Z1405201 NERO/BLACK



Chiusura velcro.  
Velcro closure.



**RFTU20011** NERO/BLACK



**RFTU100011** BLU/BLUE



Tasca porta oggetti.  
*Pocket.*



Chiusura velcro.  
*Velcro closure.*

**TUTA MECHA TOP PLUS**  
**RFTU00011** ROSSO/RED

Tasca porta attrezzi sulla gamba destra.  
Fascia elastica lombare.  
Profili e trapuntatura a contrasto.  
Polsini in maglina.  
Chiusura velcro alla caviglia.  
Taglie: da S a XXL.

*Tools pocket on right leg.  
Stretch lumbar panel.  
Quilting and piping in contrast.  
Knitted cuffs.  
Velcro ankle fastening.  
Sizes from S to XXL.*



COLORI DISPONIBILI PER LA PERSONALIZZAZIONE DELLE TUTE PROF-X E TOP PLUS  
COLOURS AVAILABLE FOR CUSTOMIZATION OF PROF-X AND TOP PLUS SUITS.



GIALLO CHIARO  
LIGHT YELLOW



BLU NAVY  
NAVY BLUE



BIANCO  
WHITE



GIALLO SCURO  
DARK YELLOW



VERDE SCURO  
DARK GREEN



GRIGIO SCURO  
DARK GREY



GRIGIO CHIARO  
LIGHT GREY



VERDE CHIARO  
LIGHT GREEN

**TUTA PRO TEAM**  
**Z1403401** ROSSO/RED

Tasca porta attrezzi sulla gamba destra.  
Profili in contrasto.  
Polsini in maglina.  
Chiusura velcro alla caviglia.  
Taglie: da S a XXL.

*Tools pocket on right leg.  
Piping in contrast.  
Knitted cuffs.  
Velcro ankle fastening.  
Sizes from S to XXL.*



**Z1403201** NERO/BLACK



**Z1403101** BLU/BLUE



Tasca porta oggetti.  
*Pocket.*



Chiusura velcro.  
*Velcro closure.*



**KFTU0003**

Prodotta in materiale lattice.  
Taglie: da XS a XXL.

*Made with latex material.  
Sizes: from XS to XXL.*



# Scarpe Shoes

## STREET MECHA (OMOLOGATE FIA) STREET MECHA (FIA APPROVED)

**Z131610** BLU-NERO / BLUE-BLACK

Nuova scarpa in camoscio con inserti in morbida pelle Bianca al fine di una facilitazione nei movimenti.

Interno in Nomex, chiusura con Velcro per una calzata più sicura.

Suola alta con uno speciale design per un grip migliore e per facilitare i piegamenti.

Estrema leggerezza. Omologata FIA 8856-2000.  
Taglie 37-48

*Three colour suede design, with soft white leather inserts to allow easy movement.*

*Nomex lining, velcro strap for secure fit.*

*Wide sole, with special grip design allowing easy bending.*

*Lightweight.*

*FIA 8856-2000 approved.*

*Sizes 37-48*



**Z131620** NERO / BLACK



**Z131640** ROSSO-NERO  
RED-BLACK

## PADDOCK (OMOLOGATE FIA) PADDOCK (FIA APPROVED)

**Z130540** ROSSO / RED

Scarpa media in pelle scamosciata, fodera ignifuga e suola idrorepellente, oleorepellente ed antiscivolo.

Omologata FIA.

Studiata per navigatori rally e meccanici.  
Taglie disponibili: dalla 36 alla 46.

*Mid shoe in suede, fireproof lining, water-repellent and anti-slip sole.*

*FIA approved. Suitable for rally co-drivers and mechanics. Sizes: 36 to 46.*



# GUANTI MECCANICO

## MECHANICS GLOVES



### GUANTO MECA PROF MECA PROF GLOVES

**Z120420** NERO/BLACK

**Z120430** BLU/BLUE

**Z120440** ROSSO/RED

Guanto meccanico con dorso in maglina colorata e palmo in pelle di capra con antiscivolo color nero.

Chiusura velcro sul polso.

Nuovo design Sabelt sul dorso

Taglie S, M, L, XL

*Knitted coloured back gloves, palm in goat leather with black rubber peening.*

*Velcro wrist fastening.*

*New Sabelt design on back.*

*Sizes S, M, L, XL*



### Z120460

Guanto in maglina di cotone peso medio.

Colore: Ecrù.

Palmo con antiscivolo nero.

Taglia unica

*Knitted cotton gloves medium weight*

*Black rubber peening for better grip on the palm.*

*Colour: natural white.*

*One size.*



### Z120660 BIANCO/WHITE

Guanto in maglina di cotone da 300gr, maniccotto lungo.

Palmo con antiscivolo arancione.

Colore: Ecrù.

Taglia unica

*Knitted cotton gloves 300gr., long cuff.*

*Orange rubber peening for better grip on the palm.*

*Colour: natural white.*

*One size.*



### Z120360

Guanto in maglina di cotone da 180gr, maniccotto lungo.

Palmo con antiscivolo arancione.

Colore: Ecrù.

Taglia unica.

*Knitted cotton gloves 180gr., long cuff.*

*Orange rubber peening for better grip on the palm.*

*Colour: natural white.*

*One size.*

### GREMBIULE DA LAVORO WORK APRON

**KFAC0009** NERO/BLACK



### CINTURA SPORTSWEAR SPORTSWEAR BELT

**ZBELT10** BLU ROYAL/ROYAL BLUE

**ZBELT40** ROSSO/RED

**ZBELT20** NERO/BLACK

Cintura per pantaloni in nastro con fibbia in alluminio e apertura a sgancio rapido a rotazione.

Belt for trousers in webbing with aluminium rotary quick release buckle.



# LABORATORIO SEDILI SEATS LAB

Tutti i sedili della gamma Sabelt vengono testati dinamicamente. Questa prova, prescritta dallo Standard FIA 8855/99, serve a verificare la resistenza e l'efficacia dei sedili per auto da competizione. Nel laboratorio Sabelt vengono effettuati su ogni modello di sedile in sequenza i tre lanci posteriore, laterale e ancora posteriore con valori di decelerazione minimi rispettivamente di 20g, 15g e 10g ( $g = 9,806 \text{ m/s}^2$ ), secondo le curve sotto riportate.

*All Sabelt seats are dynamically tested. This standard FIA 8855/99 test, helps to verify the resistance and effectiveness of competition seats. Sabelt Lab tests on each seat model 3 crashes: backwards, lateral and once again backwards with minimum deceleration values of 20g, 15g and 10g ( $g = 9,806 \text{ m/s}^2$ ). See following charts.*

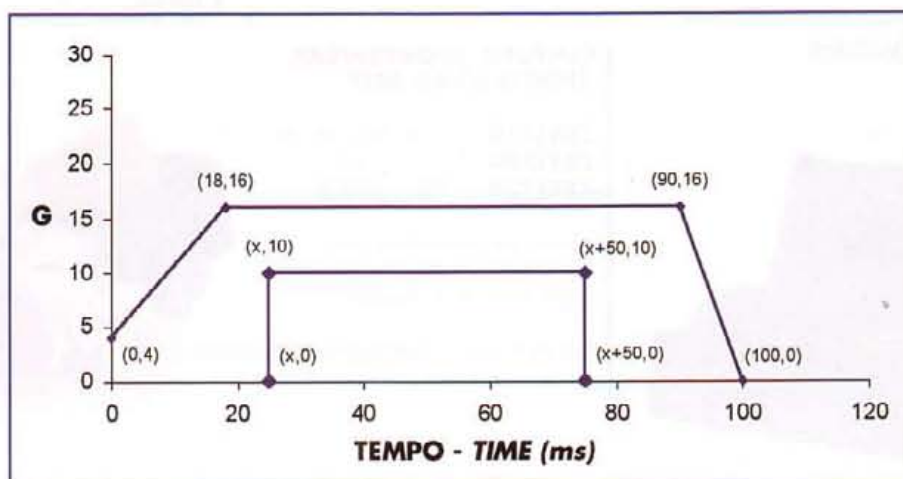
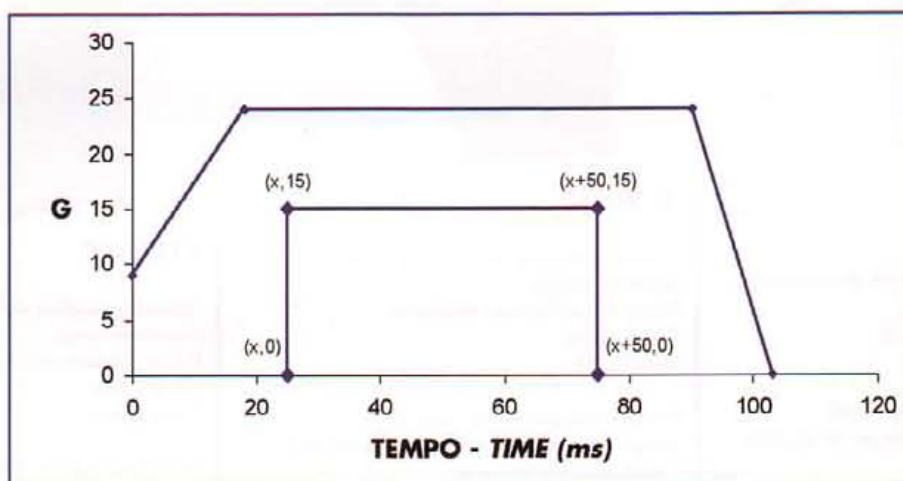
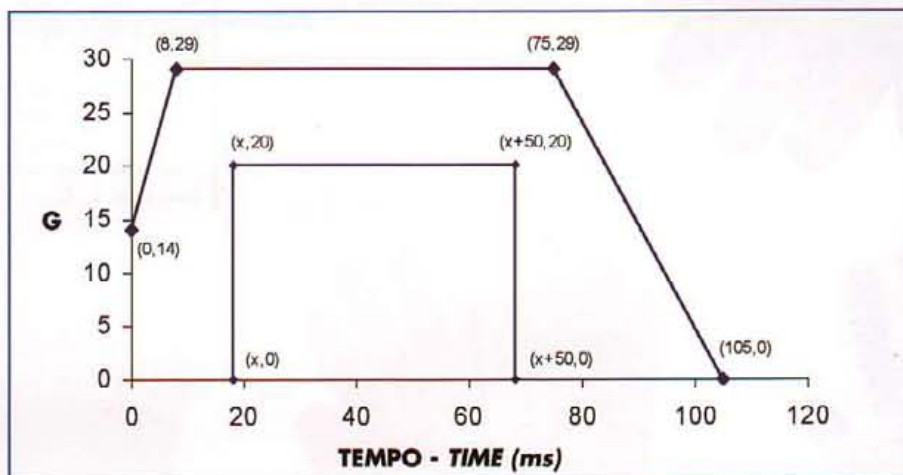



Grazie a questo avanzato ed unico laboratorio test è possibile esaminare e studiare i risultati dei crash-test che vengono giornalmente condotti, potendo così sperimentare soluzioni tecniche sempre più avanzate. Per l'utente finale tutto ciò si traduce nella disponibilità di sedili sempre più leggeri e al tempo spesso sicuri.

In particolare i test consentono di adeguare i piani di laminazione (sequenza delle operazioni con cui le fibre impregnate di resina vengono disposte nello stampo) alle variazioni della geometria dei sedili, fatto questo particolarmente importante quando si hanno varie versioni di sedile in taglia XL.

SABELT ha infatti sviluppato la nuova gamma sedili con un occhio di riguardo ai sedili di dimensioni superiori allo standard, per venire incontro alle richieste dei molti piloti che da tempo richiedevano un confort accettabile, difficile da ottenere con sedili di taglia "normale". Lo sviluppo di questi sedili è stato portato avanti tenendo conto anche delle esigenze di installazione all'interno di abitacoli non spaziosissimi; la forma particolare consente infatti una ottima abitabilità interna, riducendo l'interferenza con le barre porta del roll-bar e con il tunnel centrale, zone critiche per i sedili XL, concepiti in maniera tradizionale.

*Thanks to this advanced and unique lab test, it is possible to examine and study daily crash results, having the possibility of more advanced technical solutions. For the final user this means an offer of lighter and safer seats. These tests in particular, give the possibility to adapt to lamination plans (sequence operations where resins and fibres are prepared in the mould) to the variation to the seat geometry, particularly important when there are several versions of XL seats. SABELT has therefore developed the new series of seats with a special attention to those with larger than standard dimensions, to support the request of many drivers that have been asking since long time for an acceptable comfort, not easy to obtain with standard seats.*

*The development of these seats has been studied respecting the needs of placing inside narrow compartments; the particular shape actually permits a perfect interior habitability, lowering the interference with the door bars of the roll bar and with the central tunnel, hot spot for the XL seats designed in traditional way.*



# SEDILE TAURUS CARBON

## TAURUS CARBON SEAT



### CARBONIO CARBON RFSE0007C ROSSO/RED

Scocca in carbonio, pre-preg lavorato in autoclave  
Dispositivo contenimento testa integrato.  
5 fori passacintura.  
Cuscino standard rimovibile.  
Fissaggio con attacchi laterali.  
Compatibile con sistema HANS®.  
Omologato FIA.

*Carbon fiber shell, autoclave, pre-preg fiber  
Built-in head support.  
5 harness slots.  
Standard removable leg cushion.  
Side mount.  
HANS® compatible.  
FIA approved.*

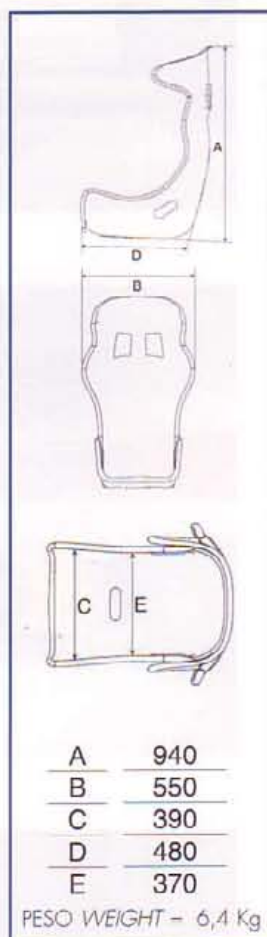

RFSE1007C BLU NAVY/NAVY BLUE



RFSE2007C NERO/BLACK



Z500140 |  
Z500930 |  
ROSSO RED

Z500120 |  
Z500920 |  
NERO BLACK

Z500110 |  
Z500910 |  
BLU NAVY NAVY BLUE

COMFORT PRO KIT  
cuscino doppia densità con  
memoria di forma per migliorare  
il comfort  
COMFORT PRO KIT  
Double density memory foam  
designed for improved comfort

# SEDILE TAURUS XL

## TAURUS XL SEAT



### VETRORESINA FIBERGLASS RFSE2007XL NERO/BLACK

Scocca in fibra di vetro finitura gel-coat.  
Dispositivo contenimento testa integrato.  
5 fori passacintura.  
Cuscino standard rimovibile.  
Fissaggio con attacchi laterali.  
Compatibile con sistema HANS®.  
Versione XL.  
Omologato FIA.

*Gel-coated Fibreglass shell.  
Built-in head support.  
5 harness slots.  
Standard removable leg cushion.  
Side mount.  
HANS® compatible.  
XL version.  
FIA approved.*



A	940
B	595
C	420
D	493
E	420-500

PESO WEIGHT = 11,3 Kg

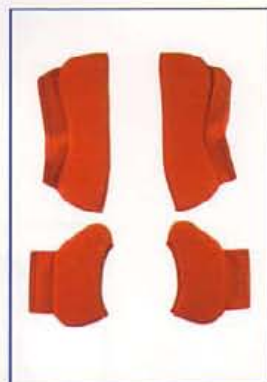

**RFSE1007XL** BLU NAVY/NAVY BLUE



**RFSE0007XL** ROSSO/RED

### Z500840

ROSSO RED

### Z500810

BLU NAVY NAVY BLUE

### Z500820

NERO BLACK

Kit sedili riduttori di taglia

*Seat size reducers Kit*

# SEDILE TAURUS L

## TAURUS L SEAT



### VETRORESINA FIBERGLASS RFSE0007L ROSSO/RED

Scocca in fibra di vetro finitura gel-coat.  
Dispositivo contenimento testa integrato.  
5 fori passacintura.  
Cuscino standard rimovibile.  
Fissaggio con attacchi laterali.  
Compatibile con sistema HANS®.  
Versione L.  
Omologato FIA.

*Gel-coated Fibreglass shell.  
Built-in head support.  
5 harness slots.  
Standard removable leg cushion.  
Side mount.  
HANS® compatible.  
L version  
FIA approved.*

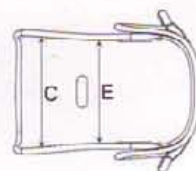
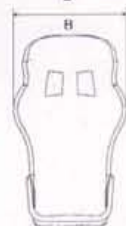

A	945
B	585
C	410
D	465
E	390

PESO WEIGHT = 10,9 Kg



RFSE1007L BLU NAVY/NAVY BLUE



RFSE2007L NERO/BLACK

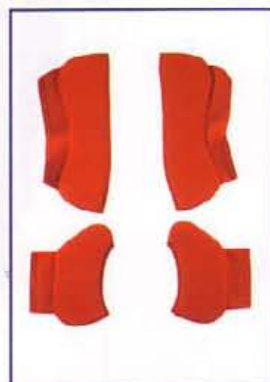

cod. pag 81

# SEDILE TAURUS M

## TAURUS M SEAT



### VETRORESINA FIBERGLASS RFSE1007 BLU NAVY/NAVY BLUE

Scocca in fibra di vetro finitura gel-coat.  
Dispositivo contenimento testa integrato.  
5 fori passacintura.  
Cuscino standard rimovibile.  
Fissaggio con attacchi laterali.  
Compatibile con sistema HANS®.  
Versione M  
Omologato FIA.

*Gel-coated Fibreglass shell.  
Built-in head support.  
5 harness slots.  
Standard removable leg cushion.  
Side mount.  
HANS® compatible.  
M version  
FIA approved.*

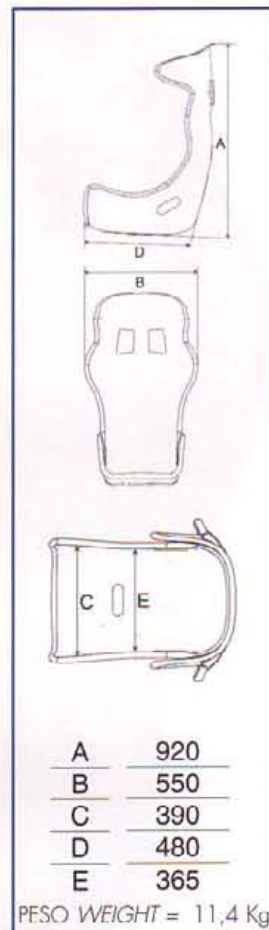
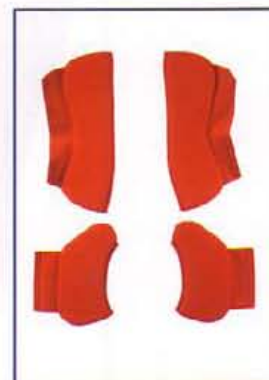

Photo Bernard Asset - Renault Sport



RFSE2007 NERO/BLACK



RFSE0007 ROSSO/RED

cod. pag 81

# SEDILE CHALLENGE CARBON XL CHALLENGE CARBON XL SEAT



## RFSE0009XLC ROSSO/RED

Scocca in carbonio, imbottitura professionale.  
Fianchi alti per maggior contenimento delle gambe e del bacino.  
5 fori passacintura.  
Cuscino seduta sdoppiato.  
Compatibile sistema HANS\*.  
Fissaggio laterale.  
Versione XL  
Omologato FIA.

*Carbon fiber shell, professional foam.  
Higher sides for increased lateral support.  
5 harness slots.  
Split leg cushion  
Side mount.  
HANS\* compatible.  
XL version.  
FIA approved.*

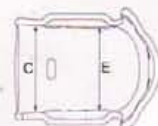
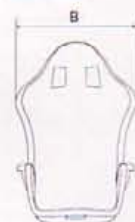

A	930
B	590
C	420
D	480
E	420-510

PESO WEIGHT = 6,2 Kg



RFSE1009XLC BLU NAVY/NAVY BLUE



RFSE2009XLC NERO/BLACK

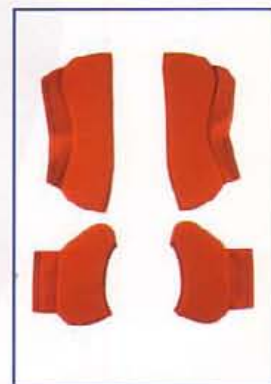

cod. pag 81

# SEDILE CHALLENGE CARBON

## CHALLENGE CARBON SEAT



**RFSE2009C** NERO/BLACK

Scocca in carbonio, imbottitura professionale.  
 Fianchi alti per un maggior contenimento  
 delle gambe e del bacino.  
 5 fori passacintura.  
 Cuscino seduta sdoppiato.  
 Compatibile sistema HANS®.  
 Fissaggio laterale.  
 Versione M  
 Omologato FIA.

*Carbon shell, professional foam.  
 Higher sides for increased lateral support.  
 5 harness slots.  
 Split leg cushion.  
 Side mount.  
 ILANS® compatible.  
 M version.  
 FIA approved.*

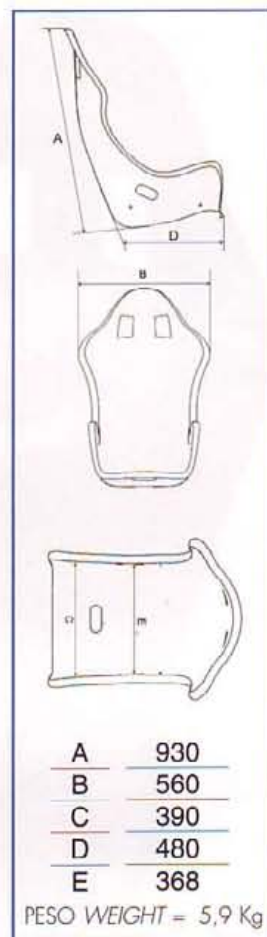

**RFSE1009C** BLU NAVY/NAVY BLUE



**RFSE0009C** ROSSO/RED



# SEDILE CHALLENGE XL

## CHALLENGE XL SEAT



### RFSE0009XL ROSSO/RED

Monoscocca in fibra di vetro finitura gel-coat.  
 Imbottitura professionale  
 Fianchi alti per maggior contenimento delle gambe e del bacino.  
 5 fori passacintura.  
 Cuscino seduta sdoppiato.  
 Compatibile sistema HANS®.  
 Fissaggio laterale.  
 Versione XL  
 Omologato FIA.

*Gel-coated fiberglass shell, professional foam.  
 Higher sides for increased lateral support.  
 5 harness slots.  
 Split leg cushion.  
 Side mount.  
 HANS® compatible.  
 XL version.  
 FIA approved.*

A	930
B	590
C	420
D	480
E	420-510

PESO WEIGHT = 9,9 Kg



RFSE1009XL BLU NAVY/NAVY BLUE



RFSE2009XL NERO/BLACK



cod. pag 81

# SEDILE CHALLENGE

## CHALLENGE SEAT

**RFSE1009** BLU NAVY / NAVY BLUE

Scocca in vetroresina, imbottitura professionale.  
 Fianchi alti per un maggior contenimento  
 delle gambe e del bacino.  
 5 fori passacintura.  
 Cuscino seduta sdoppiato.  
 Compatibile sistema HANS®.  
 Fissaggio laterale.  
 Versione M  
 Omologato FIA.

*Gel-coated fiberglass shell, professional foam.  
 Higher sides for increased lateral support.  
 5 harnesses slots.  
 Split leg cushion.  
 Side mount.  
 HANS® compatible.  
 M version.  
 FIA approved.*

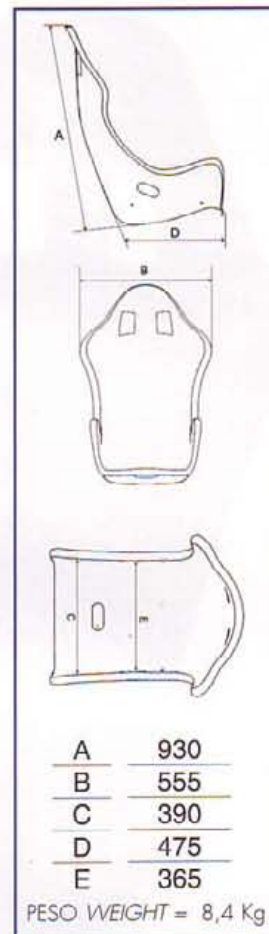

**RFSE2009** NERO/BLACK



**RFSE0009** ROSSO/RED



cod. pag 81

# SEDILE TITAN XL

## TITAN XL SEAT



### RFSE2001XL NERO/BLACK

Monoscocca in fibra di vetro finitura gel-coat.  
 Fianchi alti per maggior contenimento delle gambe e del bacino.  
 5 fori passacintura.  
 Compatibile sistema HANS®.  
 Fissaggio laterale,  
 Versione XL  
 Omologato FIA.

*Gel-coated fiberglass shell.*  
*Higher sides for increased lateral support.*  
*5 harnesses slots.*  
*Side mount.*  
*HANS® compatible.*  
*XL version.*  
*FIA approved.*

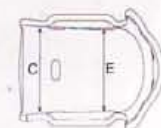
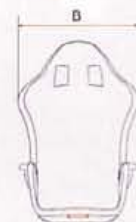

A	930
B	590
C	420
D	480
E	420-510

PESO WEIGHT = 9,8 Kg



RFSE1001XL BLU NAVY/NAVY BLUE



RFSE0001XL ROSSO/RED



cod. pag 81

# SEDILE TITAN

## TITAN SEAT



### RFSE1001 BLU NAVY/NAVY BLUE

Scocca in fibra di vetro finitura gel-coat.  
 Fianchi alti per maggior contenimento delle gambe e del bacino.  
 5 fori passacintura.  
 Cuscino standard rimovibile.  
 Fissaggio con attacchi laterali.  
 Omologato FIA.

*Gel-coated fibreglass shell.*  
*Higher sides for increased lateral support.*  
*5 harness slots.*  
*Standard removable leg cushion.*  
*Side mount.*  
*FIA approved.*



**RFSE2001** NERO/BLACK



**RFSE0001** ROSSO/RED

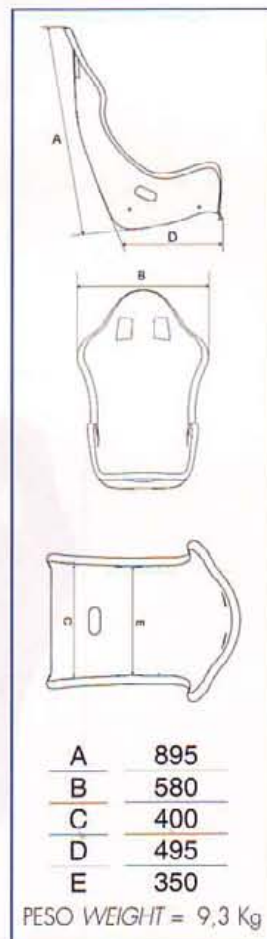

# SEDILE GT3

## GT3 SEAT



### RFSE2014 NERO/BLACK

Scocca in VTR, finitura gel-coat  
 Fianchi ribassati per agevole accessibilità  
 Fondello anti-submarining  
 Attacchi laterali  
 Compatibile HANS®  
 Versione L.  
 Omologato FIA

*Gel-coated fiberglass shell  
 Lowered sides for easy entry  
 Anti-submarining bottom  
 Side mount  
 HANS® compatible.  
 L version.  
 FIA approved.*

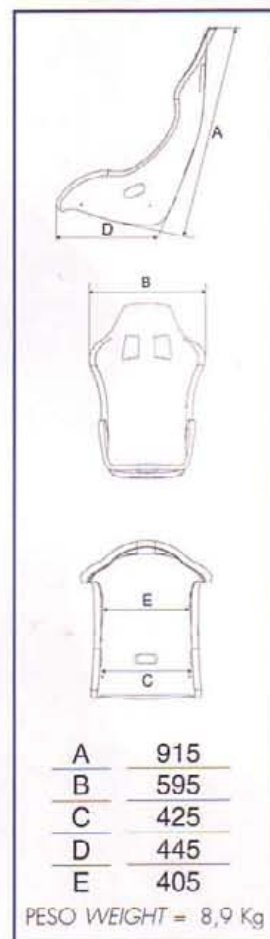

**RFSE0014**  
ROSSO/RED



**RFSE3014**  
BLU NAVY/NAVY BLUE



**RFSE1014**  
BLU ROYAL/ROYAL BLUE

# SEDILE GT2 GT2 SEAT



## Z100920/2 NERO/BLACK

Scocca in fibra di vetro finitura gel-coat.  
5 fori passacintura.  
Cuscino standard rimovibile.  
Fianchetti seduta ribassati.  
Fissaggio con attacchi laterali.  
Omologato FIA.

*Gel-coated fibreglass shell.  
5 harness slots.  
Removable standard leg cushion.  
Lower side support.  
Side mount.  
FIA approved.*

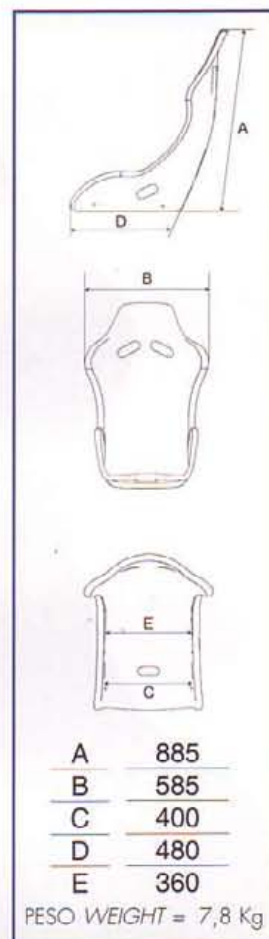

Z100940/2  
ROSSO/RED



Z100930/2  
BLU ROYAL/ROYAL BLUE



Z100910/2  
BLU NAVY/NAVY BLUE

# SEDILE GT1 GT1 SEAT



**Z100920** NERO/BLACK

Scocca in fibra di vetro rivestito completamente in tessuto.  
Poggiareni integrato.  
Cuscino standard rimovibile.  
5 fori passacintura.  
Fissaggio con attacchi laterali.  
Omologato FIA.

*Fibreglass shell, upholstered back.  
Integrated lumbar support.  
Removable standard leg cushion.  
5 harness slots.  
Side mount.  
FIA approved.*

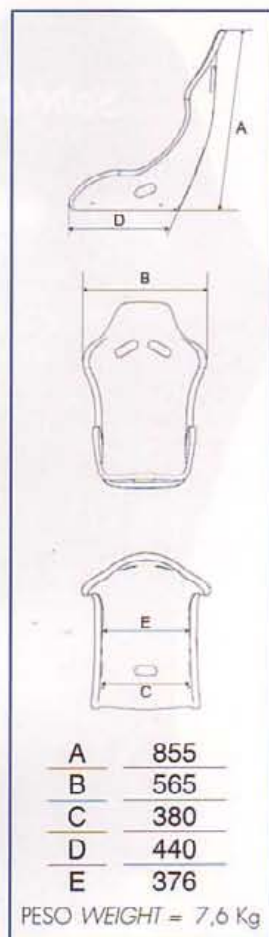

**Z100940**  
ROSSO/RED



**Z100910**  
BLU NAVY/NAVY BLUE



**Z100930**  
BLU ROYAL/ROYAL BLUE

# SEDILE RACER DUO

## RACER DUO SEAT



### Z101040L ROSSO/RED

Struttura tubolare in acciaio totalmente rivestito in tessuto.  
Cuscino standard rimovibile.  
5 fori passacintura.  
**Doppi attacchi: laterali e inferiori.**  
Compatibile sistema HANS®.  
Omologato FIA.

*Totally fabric covered tubular steel frame.  
Removable standard leg cushion.  
5 harness slots.  
**Both side and bottom mount.**  
HANS® compatible.  
FIA approved.*

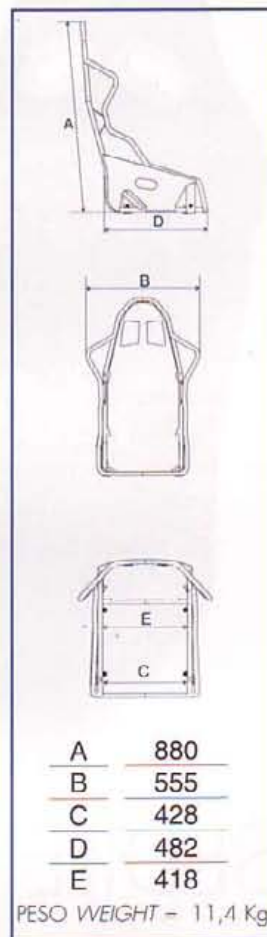

**Z101030L**  
BLU ROYAL/ROYAL BLUE



**Z101010L**  
BLU NAVY/NAVY BLUE



**Z101020L**  
NERO/BLACK

# SEDILE RACER SKY RACER SKY SEAT



**Z1010205** NERO/BLACK

Struttura tubolare in acciaio rivestito in vinile lavabile.  
Cuscino fisso.  
5 fori passacintura.  
Doppi attacchi: laterali e inferiori.  
Omologato FIA.

*Tubular steel frame, vinyl washable cover.  
Fixed leg cushion.  
5 harness slots.  
Both side and bottom mount.  
FIA approved.*

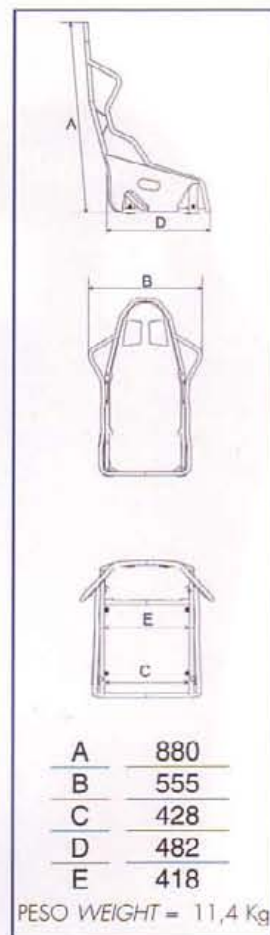

# SEDILE GRASSHOPPER GRASSHOPPER SEAT

**Z100800** NERO/BLACK

Scocca in vetroresina rivestita in vinile lavabile.  
Sedile per il kart cross.  
Adatto anche per alcuni modelli di auto d'epoca.  
Attacchi inferiori.  
3 fori passacintura.  
Cuscino fisso.

*Kart cross adults seat.  
Fibreglass shell vinyl covered.  
It fits also on some historic cars.  
Bottom mount.  
3 harness slots.  
Fixed cushion.*

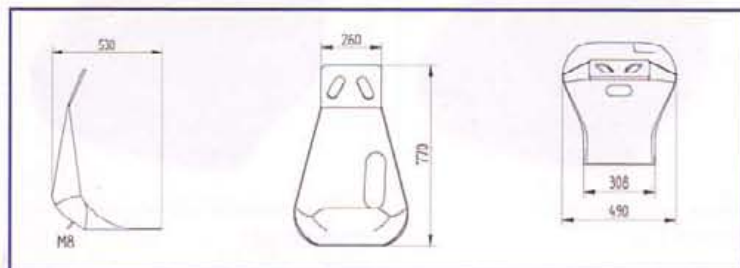

# ACCESSORI SEDILI SEATS ACCESSORIES



- Z500710** BLU NAVY/NAVY BLUE
- Z500720** NERO/BLACK
- Z500740** ROSSO/RED
- Z500730** BLU ROYAL/ROYAL BLUE

Cuscino di supporto lombare adattabile a tutta la gamma dei sedili Sabelt.

*Lumbar support, it fits to all Sabelt range of seats.*



- Z500511** BLU NAVY/NAVY BLUE
- Z500520** NERO/BLACK
- Z500540** ROSSO/RED
- Z500530** BLU ROYAL/ROYAL BLUE

Cuscino poggiatesta.  
Adattabile a tutta la gamma dei sedili Sabelt.

*Leg cushion.  
Fits to all Sabelt range of seats.*



- Z500420** NERO/BLACK

2 cuscini di contenimento laterale.

*Two side support cushion.  
Fits to all Sabelt range of seats.*



- Z500220** NERO/BLACK

Cuscino base sedile.  
Adattabile a tutta la gamma dei sedili Sabelt.

*Seat base cushion.  
Fits to all Sabelt range of seats.*



- Z200004**

Attacchi laterali in acciaio 3 mm, conforme FIA.  
Lunghezza standard Verniciatura epossidica nera.

*Steel brackets for side mounting 3 mm thickness.  
FIA compliance, standard length, black epoxy painted.*



- Z200005F**
- Z200005XL**

Attacco laterale, in alluminio 5 mm,  
lavorato a CNC  
conforme FIA, lunghezza standard, anodizzata in nero.  
Differenti offset

*Aluminium brackets for side mounting 5 mm thickness CNC  
machined, FIA compliance, standard length, black anodized.  
Various offset*



- Z200045B**

Attacco laterale, in alluminio 5 mm, conforme FIA.  
Allungata e alleggerita, verniciata in nero.

*Aluminium brackets for side mounting 5 mm thickness.  
FIA compliance, extra length, lightened, black painted.*



- Z200005B**

Attacco laterale, in alluminio 5 mm, conforme FIA.  
Lunghezza standard, verniciata in nero.

*Aluminium brackets for side mounting 5 mm thickness.  
FIA compliance, standard length, black painted.*

# ROLL BAR ROLL CAGES

I roll bar Sabelt si distinguono per la qualità di fabbricazione e di progettazione, senza compromessi per la sicurezza: strutture generosamente dimensionate e pensate con l'ottica del cliente finale, di chi cioè il roll bar lo va a montare in vettura.

La gamma, di facile montaggio, si compone di roll bar multipunti omologati al Cr Mo, e di roll bar in acciaio E235 conformi all'Allegato "J" della FIA.

La modalità di montaggio è la saldatura per i multipunti al Cr Mo, e mista saldatura/imbullonatura per quelli conformi all' Allegato "J".

*Sabelt roll cages are characterized by the high quality in production and development, without making any compromise with safety: well dimensioned structures designed following final customer's needs.*

*Easy mounting Sabelt roll cages range includes CrMo multipoints homologated and steel E235 ones which comply FIA annex J.*

*Multipoints roll cages have to be welded while annex J ones might be bolt-in or bolt-in and welded.*



## 1 CITROËN C2

Z250CR001

25 CrMo4 acciaio saldato. 25 CrMo4 steel.

## 2 MITSUBISHI EVO8 - EVO9

Z250CR003

Z250CR003OPT (Optional Kit)

25 CrMo4 acciaio saldato. 25 CrMo4 steel.

## 3 CITROËN C2

Z250J003

E235 acciaio imbullonato. E235 steel bolted-in.

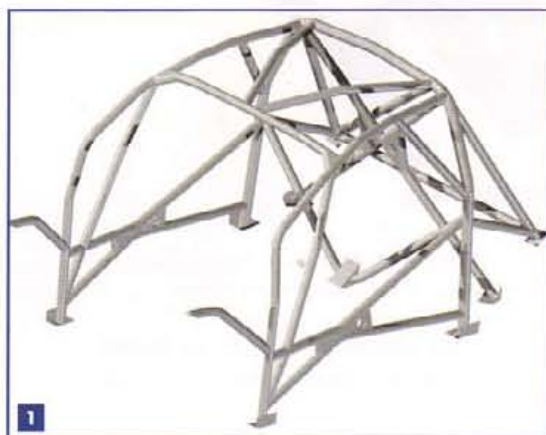



**FORD FIESTA ST150**

E235 Acciaio imbullonato

*E235 Steel bolted-in*

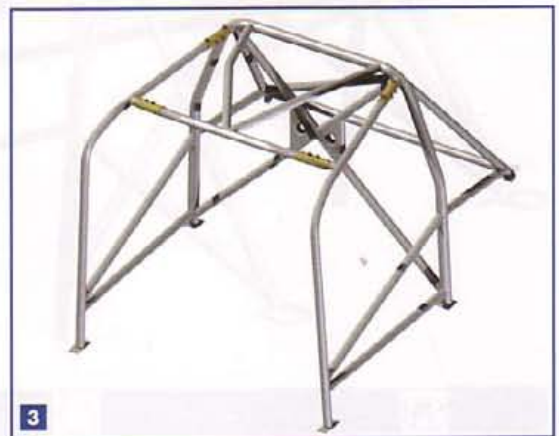
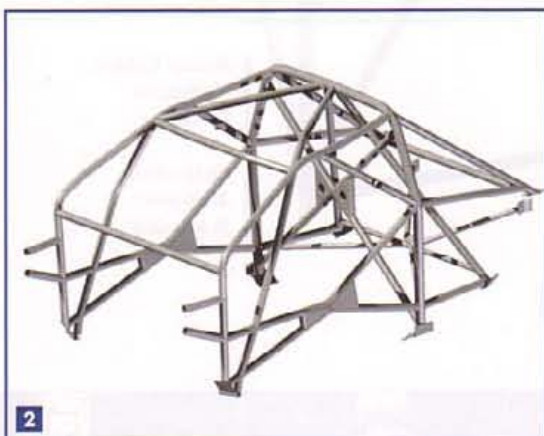

La gamma dei roll bar Sabelt si compone di 4 tipologie principali: da saldare, da imbullonare, gabbia e multipunti.

The range of Sabelt roll bars consists of 4 main types: to be bolted, to be welded, cage and multipoints.



Acciaio Fe45 da imbullonare.  
Rinforzi porta.

*Fe45 steel to be bolted-in.  
Door bars.*



Acciaio Fe45.  
Ricambi anteriori.

*Fe45 steel.  
Front spare part.*



Acciaio CRMO.  
Multipunti.  
Da imbullonare.

*CRMO steel.  
Multi-point.  
To be bolted-in.*

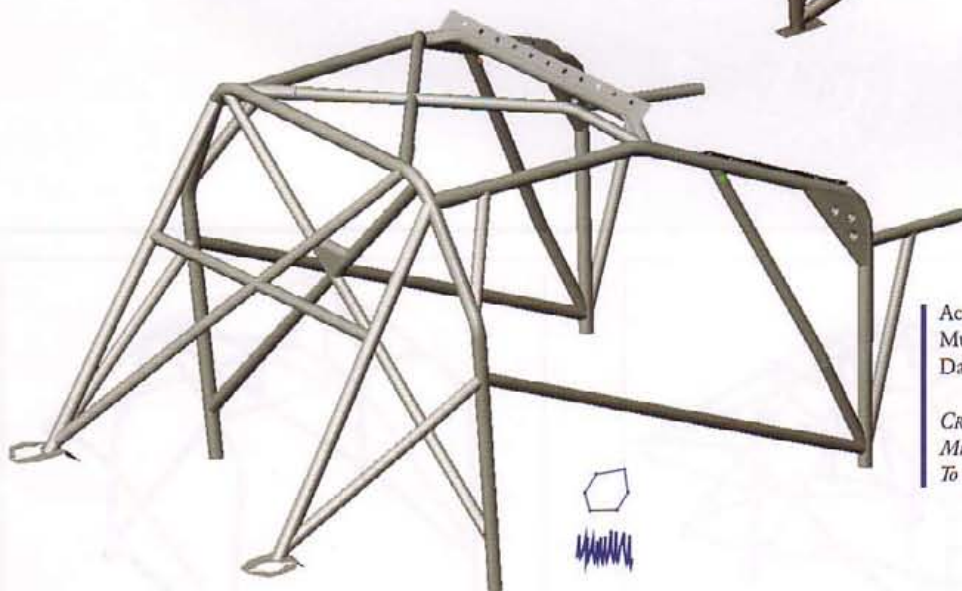

Acciaio CRMO.  
Multipunti.  
Da saldare.

*CRMO steel.  
Multi-point.  
To be welded.*

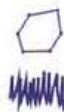

Acciaio Fe45 da imbullonare.  
Croce su arco principale.  
Rinforzi porta e diagonale posteriore.

*Fe45 steel to be bolted-in.  
Transversal rear brace.  
Door bars and roof diagonal.*

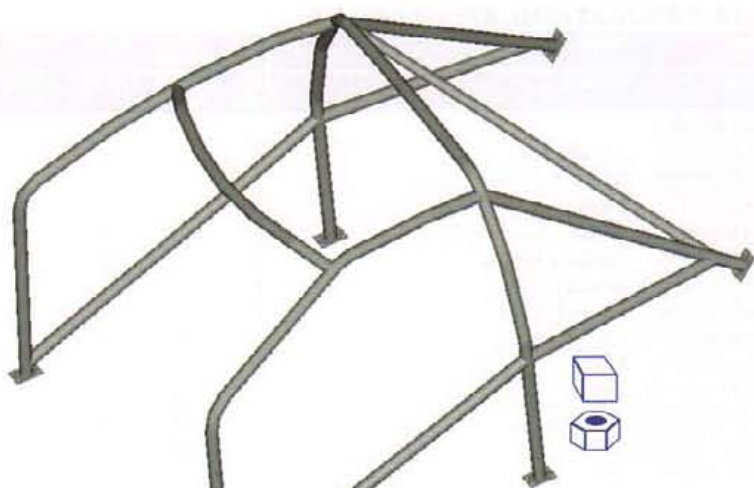

Acciaio Fe45 da saldare.  
Multipunti.

*Fe45 steel to be welded.  
Multi-points.*

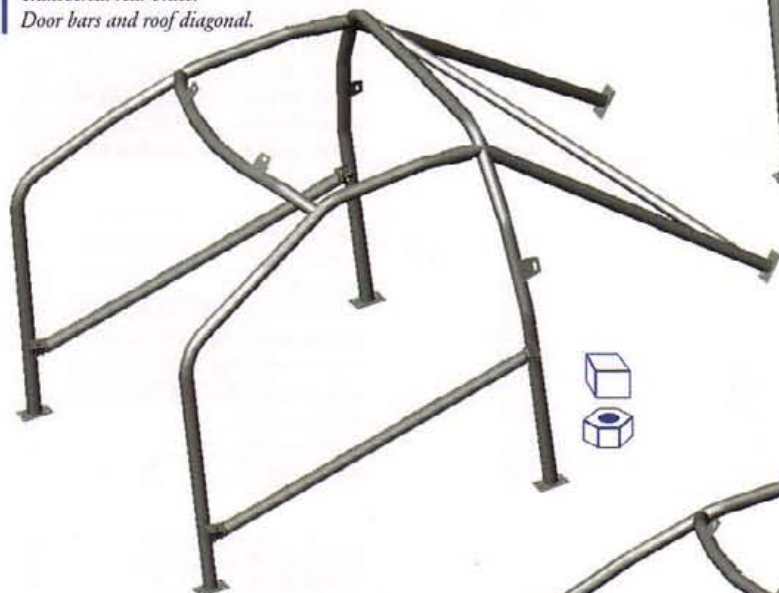

Acciaio Fe45 da imbullonare.  
Completo di rinforzi porta.  
Multipunti.

*Fe45 steel to be bolted-in.  
Door bars.  
Multi-points.*

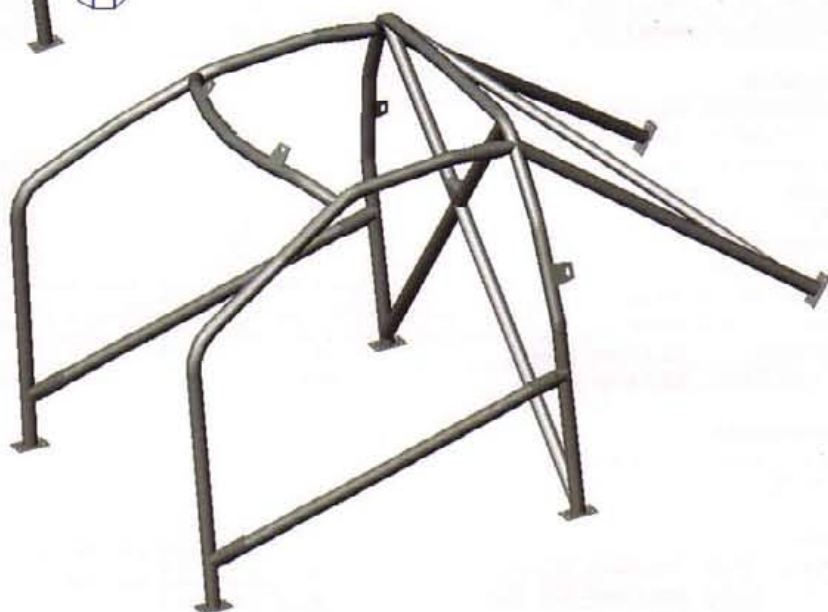

## Protezioni Roll Bar Roll Cages paddings



**435020** NERO/BLACK  
**435040** ROSSO/RED

Coppia di protezioni imbottite. Non omologata

*Roll cage paddings, not approved*



**Z50030N** NERO/BLACK

Lunghezza 915 mm. Diametro 38/42. Protezioni omologate FIA.

*FIA approved paddings, length 915mm. Diameter 38/42*

**Z50031N** NERO/BLACK

Lunghezza 915 mm. Diametro 44/50. Protezioni omologate FIA.

*FIA approved paddings, length 915mm. Diameter 44/50*

**LISTA APPLICAZIONI APPLICATIONS**

CODICE	MODELLO	GABBIA STD	MULTI PUNTI	FE 45	CRMO	OMOL.	ALLEGATO J	FISSAGGIO	ALLEGATI	PESO
CODE	MODEL	STD CAGE	MULTI POINT	FE 45	CRMO	HOMOL.	ANNEX J	MOUNTING	ATTACHMENTS	WEIGHT
<b>ALFA ROMEO</b>										
RAA/104P/1	33/ alfa sud	6		*				imbull. bolted		
RAA/104P/2	GT/GTA 2 porte 2 doors	6		*				imbull. bolted		
RAA/104P/3	1900	6		*				imbull. bolted		
RAA/104P/9	Giulia 4 porte 4 doors	6		*				imbull. bolted		
RAA/104P/4	Giulietta berlina	6		*				imbull. bolted		
RAA/104P/5	Alfetta GTV	6		*				imbull. bolted		
RAA/104P/6	Alfasud Sprint	6		*				imbull. bolted		
RAB/105P/212	Grv 3.0 V6		8	*			FIA	imbull. bolted	E	27
RAA/104P/7	1750	6		*				imbull. bolted		
RAB/105P/13	145		10	*			FIA	imbull. bolted		26,5
RAB/105P/204	146		10	*			FIA	imbull. bolted	E	27
RAB/105/222A	147		M.P.	*			FIA	saldato welded	AB	38
RAA/104P/8	75	6		*				imbull. bolted		
RAA/104/8S	75		8	*			FIA	imbull. bolted	ACD	35
RAB/106/12A	155		M.P.	*			ONS	saldato welded	ABCDEFGHIJKLM	38
RAB/105/203A	156		M.P.	*			FIA	saldato welded	ABCD	38
RAB/106/203A	156		M.P.	*			RAC	saldato welded	ABCDEFGHIKL	37
<b>BMW</b>										
RAA/104P/15	1602/2002	6		*				imbull. bolted		
RAA/104P/16	Serie 3 E21 320/320i/323 >75<83	6		*				imbull. bolted		
RAA/104P/17	Serie 3 E30 2 porte 2 doors >83<91	6		*			ONS	saldato welded		
RAB/106/17B	Serie 3 E30 2 porte 2 doors >83<91		M.P.	*			ONS	imbull. bolted	ABCDEFGHIJK	36
RAB/106/17A	Serie 3 E30 2 porte 2 doors >83<91		M.P.	*			ONS	saldato welded	ABCDEFGHIJK	34
RAB/106/18A	Serie 3 E36 Coupè >92		M.P.	*			ONS	saldato welded	ABCDEFGHIJKLM	43
RAB/106/19A	Serie 3 Compact		M.P.	*			ONS	saldato welded	ABCDEFGHIJLM	41
RAB/105/218AS	Serie 3 E46 320		M.P.	*			FIA	saldato welded		46
RAB/105/218A	Serie 3 E46 320		M.P.	*			FIA	saldato welded		38
RAB/100/237A	Serie 5 E39		10	*			FIA	saldato welded	E	
<b>CITRÖEN</b>										
RAB/105P/21	Visa 3 porte 3 doors	6		*			FIA	imbull. bolted		26
RAB/105P/23	AX 3 porte 3 doors		8	*			ONS	imbull. bolted		26
RAB/105P/182	Saxo		10	*			FIA	imbull. bolted		26
RAB/105/182A	Saxo		M.P.	*			RAC	saldato welded	ABC	38
RAB/106/182A	Saxo		M.P.	*			RAC	saldato welded	ABCDEGJLM	38
RAB/105P/24	ZX 3 porte 3 doors		10	*			ONS	imbull. bolted		25,5
RAB/106/24A	ZX		M.P.	*			ONS	saldato welded	ABCDEFGHIJKLM	36
RAB/105P/209	XSara		10	*			FIA	imbull. bolted	E	25
RAB/106/209A	XSara		M	*			RAC	saldato welded	ABCDEFGHIJKLM	50
Z250J003	C2 3 porte 3 doors	6		*				Imbullonato Bolted	ABDIINO	36
Z250CR001	C2 3 porte 3 doors	M.P.		*			R.F.E.deA.	Saldato Welded	ABCDEHMNO	48
<b>CHEVROLET</b>										
RAB/105P/207	Daewoo Lanos 3 porte 3 doors		10	*			FIA	imbull. bolted	E	25
Z250J002	Aveo / Daewoo Kalos 3 p. 3 doors	6		*				Imbullonato Bolted	ABDEHNO	36
<b>FIAT</b>										
RAA/104P/28	500 Abarth 595/695	6		*				imbull. bolted		
RAA/104P/30	600 Abarth 850/ 1000	6		*				imbull. bolted		
RAA/104P/29	126	6		*				imbull. bolted		
RAB/105P/214	Cinquecento Sporting		8	*			FIA	imbull. bolted		27
RAB/105P/214	Seicento Sporting		8	*			FIA	imbull. bolted		27
RAB/106/214	Seicento Sporting		M.P.	*			RAC	imbull. bolted	ABGKL	28
RAA/104P/46	Panda	6		*				imbull. bolted		
RAA/104P/32	127	6		*				imbull. bolted		
RAA/104P/47	Uno	6		*			ONS	imbull. bolted		
RAA/104/47S	Uno		M.P.	*				imbull. bolted		
RAA/104P/34	128 berlina 4 porte 4 doors	6		*				imbull. bolted		
RAA/104P/35	128 berlina 2 porte 2 doors	6		*				imbull. bolted		
RAA/104P/36	128 coupè 3 porte 3 doors	6		*				imbull. bolted		
RAA/104P/48	Ritmo	6		*			ONS	imbull. bolted		
RAB/105P/50	Punto 2ª serie 1.8 16v HGT>9/99	10		*			FIA	imbull. bolted	E	27
RAB/105/50AS	Punto 3 porte 3 doors >09/99		M.P.	*			RAC	saldato welded	ABCD	58
RAB/106/49B	Tipo 5 porte 5 doors		M.P.	*			ONS	imbull. bolted	ABCDEFGHIHIM	34
RAB/106/49A	Tipo 5 porte 5 doors		M.P.	*			ONS	saldato welded	ABCDEFGHIHIM	30
RAB/105P/227	Stilo 3 porte 3 doors >10/01		8	*			FIA	imbull. bolted	E	35
RAA/104P/43	X1/9	6		*				imbull. bolted		
RAB/105P/51	Coupè		10	*			FIA	imbull. bolted	E	27

CODICE	MODELLO	GABBIA STD	MULTI PUNTI	FE 45	CRMO	OMOL.	ALLEGATO J	FISSAGGIO	ALLEGATI	PESO
CODE	MODEL	STD CAGE	MULTI POINT	FE 45	CRMO	HOMOL.	ANNEX J	MOUNTING	ATTACHMENTS	WEIGHT
<b>FORD</b>										
RAA/104P/60	Fiesta 1ª serie <89	6		*				*	imbull. bolted	
RAB/105P/67	Fiesta 2ª serie 3 porte 3 doors >89		10	*			FIA		imbull. bolted	27
RAB/105P/210	Fiesta 3ª serie 3 porte 3 doors >96		10	*			FIA		imbull. bolted E	27
RAA/104P/61	Escort MK 1	6		*				*	imbull. bolted	
RAA/104P/62	Escort RS 2000 16v MK2	6		*				NO	imbull. bolted	
RAA/104P/63	Escort XR3/RSTurbo/MK 3/4 sunroof <90	6		*			ONS		imbull. bolted	
RAB/105P/68	Escort Cosworth >92		10	*			FIA		imbull. bolted	27
RAB/105/68A	Escort Cosworth >92		M.P	*			FIA		saldato welded ABCD	38
RAB/106/68B	Escort Cosworth >92		M.P	*			ONS		imbull. bolted ABCDEFGHIJKL	48
RAB/106/68A	Escort Cosworth >92		M.P	*			ONS		saldato welded ABCDEFGHIJKLM	39,5
RAB/106/65	Sierra Cosworth 2 porte 2 doors		M.P	*			ONS		imbull. bolted ABCDEFGHIK	46
RAB/106/66/4A	Sierra Cosworth 4 porte 4 doors 4x4		M.P	*			ONS		saldato welded ABCDEFGHIKLM	32
<b>HONDA</b>										
RAB/105P/56	Civic 3 porte 3 doors <91		10	*			FIA		imbull. bolted	27
RAB/105P/57	Civic 3 porte 3 doors >92<95		10	*			FIA		imbull. bolted E	27
RAB/105P/216	Civic 1.6 16V V-tech VTI	6		*				NO	imbull. bolted	27
RAB/106/236A	Civic 3 porte 3 doors <09/01		M.P	*			RAC		saldato welded ABCDEFHIJKLM	33
RAB/106/229A	Civic 3 porte 3 doors <09/01		M.P	*			RAC		saldato welded ACDE	47
RAB/105P/206	Integra		10	*			FIA		imbull. bolted	27
<b>INNOCENTI</b>										
RAB/105P/224	Yugo Koral 55		10	*			FIA		imbull. bolted	25
<b>JAGUAR</b>										
RAB/100/238A	S TYPE		10	*			FIA		saldato welded E	
<b>LANCIA</b>										
RAA/104P/10	Autobianchi A112 Abarth	6		*				*	imbull. bolted	
RAA/104P/80	Fulvia Coupè HF "fanalone"	6		*				*	imbull. bolted	
RAA/104P/82	Fulvia berlina2C 4 porte 4 doors	6		*				*	imbull. bolted	
RAA/104P/86	Delta 1ª serie	6		*			ONS		imbull. bolted	
RAB/106/86B	Delta 1ª serie			*			ONS		imbull. bolted ABCDEFG	32
RAB/106/86A	Delta 1ª serie		M.P	*			ONS		saldato welded ABCDEFG	29
<b>LEYLAND</b>										
RAA/104P/70	MINI MK II / MINI COOPER	6		*				*	imbull. bolted	
<b>MAZDA</b>										
RAB/105/74/S	323 3 porte 3 doors >90		10	*			FIA		imbull. bolted ABCE	40
RAB/105/74	323 3 porte 3 doors >90		10	*			FIA		imbull. bolted	27
RAB/105P/225	MX-5 >98		10	*			FIA		imbull. bolted	27
RAB/100/240A	RX8		M.P	*			FIA		imbull. bolted E	
<b>MG</b>										
RAB/105/213A	SMGF		10	*			RAC		saldato welded AD	28
<b>MITSUBISHI</b>										
RAB/105P/211	LANCER/CARISMA EVO5		10	*			RAC		imbull. bolted	27
RAB/106/211A	LANCER/CARISMA EVO5		M.P	*			RAC		saldato welded ABCDEFGHILM	38
RAB/106/235A	LANCER EVO 7/8/8MR		M.P	*			RAC		saldato welded ABCDEFGHIJKLM	43
Z250CR003	LANCER EVO 8/9		M.P	*			R.F.E.deA.		saldato welded ABCDEFGHIJKLM	54
Z250CR003KIT	LANCER EVO 8/9		Kit rinforzi OPT				Kit reinforcement OPT			8
<b>NISSAN</b>										
RAB/100/234	MICRA 3 porte 3 doors >03		10	*			FIA		imbull. bolted E	34
RAB/106/77A	SUNNY 2.0 4WD GTI-R		M.P	*			ONS		saldato welded ABCDEFGHJL	32
<b>OPEL</b>										
RAA/104P/97	Corsa 1ª serie <92	6		*			ONS		imbull. bolted	
RAB/105P/99	Corsa 2ª serie 3 porte 3 doors >93		10	*			FIA		imbull. bolted	27
RAA/104P/91	Kadett C 1.9 GTE / 2.0 GTE <79	6		*				*	imbull. bolted	
RAA/104P/94	Kadett D	6		*				*	imbull. bolted	
RAA/104P/96	Kadett E 3 porte 3 doors	6		*			ONS		imbull. bolted	
RAB/106/96	Kadett E 3 porte 3 doors		M.P	*			ONS		imbull. bolted ABCDEFGHI	27,5
RAB/105P/98	Astra 1ª serie 3 porte 3 doors >91		10	*			FIA		imbull. bolted	27
RAB/106/98B	Astra 1ª serie 3 porte 3 doors >91		M.P	*			ONS		imbull. bolted ABCDEFGHIJLM	34
RAB/106/98A	Astra 1ª serie 3 porte 3 doors >91		M.P	*			ONS		saldato welded ABCDEFGHIJLM	32
RAB/106/223A	Astra OPC		M.P	*			RAC		saldato welded ABCDEFGJLM	42,5
RAB/105P/223	Astra OPC		10	*			FIA		imbull. bolted	26
RAA/104P/93	Ascona B/400 <78	6		*				*	imbull. bolted	
RAA/104P/95	Manta B	6		*				*	imbull. bolted	

CODICE	MODELLO	GABBIA STD	MULTI PUNTI	FE 45	CRMO	OMOL.	ALLEGATO J	FISSAGGIO	ALLEGATI	PESO
CODE	MODEL	STD CAGE	MULTI POINT	FE 45	CRMO	HOMOL.	ANNEX J	MOUNTING	ATTACHMENTS	WEIGHT
<b>PEUGEOT</b>										
RAA/104P/125	104 ZS Coupè	6		*			*	imbull. bolted		
RAB/105/129S	106 3 porte 3 doors		10	*		ONS		imbull. bolted	ABD	30
RAB/106/129B	106 3 porte 3 doors		M.P	*		ONS		imbull. bolted	ABCDEFGFI	27
RAB/106/129AE	106 3 porte 3 doors		M.P	*		ONS		saldato welded	ABCDEFGFIL	19
RAB/105P/182	106 3 porte 3 doors		10	*		FIA		imbull. bolted		26
AB/105/182A	106 3 porte 3 doors		M.P	*		RAC		imbull. bolted	ABC	38
AB/106/182A	106 3 porte 3 doors		M.P	*		RAC		saldato welded	ABCDEGJLM	38
RAB/105P/126	205 3 porte 3 doors		10	*		FIA		imbull. bolted		26
RAB/105/126A	205 3 porte 3 doors		M.P	*		FIA		imbull. bolted	ABD	27
RAB/106/126	205 3 porte 3 doors		M.P	*		ONS		imbull. bolted	ABDEFGI	26
RAB/106/126K	205 3 porte 3 doors		M.P	*		ONS		imbull. bolted	FG	16,5
RAB/105/217A	206		M.P	*		FIA		imbull. bolted	ABD	31
RAB/106/217A	206		M.P	*		RAC		saldato welded	ABCDEFGHIJLM	42
RAB/105P/130	306 3 porte 3 doors		10	*		FIA		imbull. bolted	E	28
RAB/105/130A	306 3 porte 3 doors		M.P	*		RAC		imbull. bolted	ABD	34
RAB/106/130A	306 3 porte 3 doors		M.P	*		ONS		saldato welded	ABCDEFGHIJKLM	38
RAB/105P/128	309 3 porte 3 doors		10	*		FIA		imbull. bolted		26
RAB/105/128A	309 3 porte 3 doors		M.P	*		FIA		imbull. bolted	ABD	29
RAB/106/128B	309 3 porte 3 doors		M.P	*		ONS		imbull. bolted	ABCDEFGKLI	27
RAB/106/128A	309 3 porte 3 doors		M.P	*		ONS		saldato welded	ADEFGLM	17
<b>PORSCHE</b>										
RAA/104P/131	911	6		*			*	imbull. bolted		
RAB/105P/132	356		8	*		FIA		imbull. bolted		26
<b>RENAULT</b>										
RAA/104P/135	R5 L/TL/Alpine	6		*		ONS		imbull. bolted		
RAA/104P/137	R5 Turbo (rear engine)	6		*			*	imbull. bolted		
RAB/105P/138	Super 5 GT Turbo		10	*		ONS		imbull. bolted		26
RAB/105/138A	Super 5 GT Turbo		M.P	*		FIA		saldato welded	ABD	33
RAB/106/138A	Super 5 GT Turbo		M.P	*		ONS		saldato welded	ABCDEFGHIJLM	25
RAB/105P/144	Clio 1ª serie 3 porte 3 doors		10	*		FIA		imbull. bolted		25,7
RAB/105/144A	Clio 1ª serie 3 porte 3 doors		M.P	*		FIA		saldato welded	ABD	33
RAB/106/144A	Clio 1ª serie 3 porte 3 doors		M.P	*		ONS		saldato welded	ABCDEFGHIJKL	25
RAB/105/144T	Clio 1ª serie Trofeo		12	*		ONS		imbull. bolted	AI	35
RAB/105P/220	Clio 2ª serie		10	*		RAC		imbull. bolted	A	32
RAB/105/220A	Clio 2ª serie		M.P	*		FIA		saldato welded	AB	33
RAB/106/220A	Clio 2ª serie		M.P	*		RAC		saldato welded	ABCDEFGHIJLM	35,5
RAB/106/233A	Clio 2ª serie		M.P	*		RAC		saldato welded	ABCHIKLM	48
RAA/104P/134	R8 Gordini	6		*			*	imbull. bolted		
RAA/104P/142	R11 Turbo	6		*			NO	imbull. bolted		
RAB/105P/136	Megane 2.0 16V Coach 3 porte 3 doors		10	*		FIA		imbull. bolted	E	27
RAB/105/136A	Megane 2.0 16V Coach 3 porte 3 doors		M.P	*		FIA		saldato welded	ABD	33
RAB/106/136A	Megane 2.0 16V Coach 3 porte 3 doors		M.P	*		RAC		saldato welded	ABCDIJ	40
<b>ROVER MG</b>										
RAB/100/246	ZR >2001	6		*			*	Saldato Welded		
<b>SEAT</b>										
RAA/104P/46	MARBELLA	6		*			NO	imbull. bolted		
RAB/105P/45	IBIZA 2ª serie 3 porte 3 doors >93		10	*		FIA		imbull. bolted	ABCDEFGHIJL	25
RAB/106/45A	IBIZA 2ª serie 3 porte 3 doors >93		M.P	*		ONS		saldato welded	ABCDEFGHIJI	37
RAB/106/219A	IBIZA 3ª serie >00		M.P	*		RAC		saldato welded	ABCDEFGHIJL	35
RAB/106/228A	IBIZA 4ª serie 3 porte 3 doors >01/02		M.P	*		RAC		saldato welded	EH	37
RAB/100/228	IBIZA 4ª serie 3 porte 3 doors >01/02		6	*		FIA		imbull. bolted		30
RAB/105P/226	LEON >03/00		6	*			NO	imbull. bolted	ABCDEFGHIJI	25
RAB/106/45A	CORDOBA 3 porte 3 doors		M.P	*		RAC		saldato welded		38
<b>SUBARU</b>										
RAB/105P/165	IMPREZA 2.0 4X4		10	*		FIA		imbull. bolted	E	29
RAB/106/231A	IMPREZA 2.0 4X4 >12/00		M.P	*		RAC		saldato welded	ABCDEHIJKL	57
<b>SUZUKI</b>										
RAA/104P/139	Swift 1.3 GTI 16V 3 porte 3 doors <89		8	*			NO	imbull. bolted		27
RAB/105P/180	Swift 1.3 GTI 16V 3 porte 3 doors >90		10	*		FIA		imbull. bolted	E	27
RAB/105/180S	Swift 1.3 GTI 16V 3 porte 3 doors >90		10	*		FIA		imbull. bolted	ABE	38
RAB/105P/200	Baleno		10	*		FIA		imbull. bolted	E	27
RAB/106/251A	Swift >05/2005	M.P.		*		MSA		Saldato Welded		
RAB/100/251A	Swift >05/2005	6		*			*	Saldato Welded*		
Z250J004	Swift >05/2005	6		*			*	imbull. bolted	ADHIJ	
<b>TALBOT</b>										
RAA/104P/145	Simca Rally I/Rally II	6		*			*	imbull. bolted		
RAA/104P/146	Sunbeam 1.6 TI/Lotus	6		*			*	imbull. bolted		
RAA/104P/147	Samba	6		*			*	imbull. bolted		

CODICE	MODELLO	GABBIA STD	MULTI PUNTI	FE 45	CRMO	OMOL.	ALLEGATO J	FISSAGGIO	ALLEGATI	PESO
CODE	MODEL	STD CAGE	MULTI POINT	FE 45	CRMO	HOMOL.	ANNEX J	MOUNTING	ATTACHMENTS	WEIGHT
<b>TOYOTA</b>										
RAB/105P/173	CELICA GT >94		10	*		FIA		imbull. bolted	E	29
RAB/105P/172	CELICA GT >94		8	*		FIA		imbull. bolted	E	27
RAB/100/250	Yaris 3 porte 3 doors >1999	6		*			*	Imbullonato Bolted		
<b>VOLKSWAGEN</b>										
RAB/105P/215	LUPO		6	*		FIA		imbull. bolted		27
RAA/104P/155	POLO 1ª serie >80<94	6		*		ONS		imbull. bolted		
RAB/105/208S	POLO 2ª serie <94		10	*		RAC		imbull. bolted		
RAB/106/208A	POLO 2ª serie <94		M.P.		*	RAC		saldato welded	ABCDEFGHIJKLM	35
RAB/106/157A	POLO 4ª serie 3 porte 3 doors >10/01		M.P.		*	RAC		saldato welded	ABCDEFGHIJKLM	50
RAB/106/232A	POLO 4ª serie 5 porte 5 doors >10/01		M.P.		*	RAC		saldato welded	ABCDEFGHIJKLM	50
RAA/104P/152	GOLF 1ª serie <80	6		*			*	imbull. bolted		
RAA/104P/153	GOLF 1ª serie >80<83	6		*		ONS		imbull. bolted		
RAA/104P/154	GOLF 2ª serie >84/Rally<91	6		*		ONS		imbull. bolted		
RAB/106/154B	GOLF 2ª serie >84/Rally<91		M.P.		*	ONS		imbull. bolted	ABCDEFGH	32
RAB/106/154A	GOLF 2ª serie >84/Rally<91		M.P.		*	ONS		saldato welded	ABCDEFGH	30
RAB/105P/156	GOLF 3ª serie 3 porte 3 doors >91<98		10	*		FIA		imbull. bolted		
RAB/106/156A	GOLF 3ª serie 3 porte 3 doors >91<98		M.P.		*	ONS		saldato welded	ABCDEFGHIJKLM	38
RAB/105/202S	GOLF 4ª serie 5 porte 5 doors >98		10	*		FIA		imbull. bolted	ABK	40
RAB/105P/202	GOLF 4ª serie 5 porte 5 doors >98		10	*		FIA		imbull. bolted	E	29
RAA/104P/151	SCIROCCO <79	6		*		ONS		imbull. bolted		

### SPECIFICHE ATTACHMENTS

- A rinforzi porta *door bars*
- B prolungamento rinforzi porta *extended door bar*
- C attacchi ai duomi anteriori *front turret attachmen*
- D attacchi ai duomi o alle sospensioni posteriori *rear turret attachment*
- E arco anteriore passa nel cruscotto *penetrates dashboard*
- F attacco al tetto zona alette parasole *roof attachment (front)*
- G attacchi dell'arco posteriore sul montante centrale dell'auto *B pillar attachment*
- H traversa attacco cinture posteriore *rear strut brace*
- I barra trasversale su arco principale *transverse rear brace*
- J diagonale di rinforzo sul tetto *roof diagonal*
- K rinforzi arco posteriore *reinforced rear hoop*
- L rinforzi in lamiera piegature arco anteriore *leg strenghtening sheet*
- M rinforzi laterali alti delle braccia del pilota *reinforced roof bars*



# VOLANTI STEERING WHEELS



## **RFV02008X** INDY

Volante formula.  
3 razze.  
Colore nero.  
Diametro 270 mm.  
Pelle scamosciata.

*Formula steering wheel.  
3 spokes.  
Black colour.  
270 mm diameter.  
Suede.*



## **RFV02006P** DONINGTON

Volante piatto. 3 razze.  
Colore nero.  
Diametro 300 mm.  
Pelle liscia.  
Foratura 3x PCD 2"

*Flat steering wheel. 3 spokes.  
Black colour.  
300 mm diameter.  
Smooth leather.  
3x PCD 2"*

**RFV02006P** SARDINIA

Volante piatto. 3 razze.  
Colore nero.  
Diametro 330 mm.  
Pelle scamosciata.

*Disbed steering wheel. 2 spokes.  
Black colour. Yellow top.  
350 mm diameter. 90 mm depth.  
Suede leather.*



**RFV02007X** MONACO

Volante piatto.  
3 razze.  
Diametro 350 mm.  
Pelle scamosciata nera.

*Flat steering wheel.  
3 spokes.  
350 mm diameter.  
Black suede leather.*

**RFV02006P** TURINI

Volante a calice. 2 razze.  
 Colore nero. Top giallo.  
 Diametro 350 mm. Profondità 90 mm.  
 Pelle liscia.

*Discoid steering wheel. 2 spokes.  
 Black colour. Yellow top.  
 350 mm diameter. 90 mm depth.  
 Smooth leather.*

**P110423** TURINI

Razze colorate, pelle liscia.  
*Coloured spokes, smooth leather.*

**X110423**

Razze colorate, pelle scamosciata.  
*Coloured spokes, suede leather.*

**RFV02006X**

Razza nera, pelle scamosciata.  
*Black spokes, suede leather.*

**RFV02005X**  
AKROPOLIS

Volante a calice, 3 razze.  
 Diametro 350 mm. Profondità 90 mm.  
 Razze nere, pelle scamosciata.

*Discoid steering wheel. 3 spokes, 350 mm diameter.  
 90 mm depth.  
 Black colour, suede leather.*

**X110523** AKROPOLIS

Razze colorate. Pelle scamosciata.  
*Coloured spokes, suede leather.*

**P110523**

Razze colorate, pelle liscia.  
*Coloured spokes, smooth leather.*

**RFV02005P**

Razze nere, pelle liscia.  
*Black spokes, smooth leather.*

**RFV02009X** RAC

Volante a 1/2 calice.  
3 razze.  
Diametro 350 mm.  
Profondità 65 mm.  
Pelle scamosciata.  
Razze nere

*1/2 dish steering wheel.  
3 spokes.  
350 mm diameter.  
65 mm depth.  
Black spokes, suede leather.*



Photo Bernard Asset - Renault Sport



# MOZZI HUBS

Vedere listino prezzi per la lista applicazioni.  
*Cf. pricelist for application list.*

**P001** PULSANTE CLACSON  
PUSH-BUTTON



MOZZI COLLASSABILI.  
COLLAPSIBLE HUB KIT.



MOZZI FISSI.  
FIXED HUB KIT.



# IMPIANTI ESTINZIONE FIRE EXTINGUISHING SYSTEM

Tutta la gamma degli impianti estinzione utilizza il nuovo estinguente Sablife. *All the range of fire extinguishers uses the new Sablife system.*

**Sablife**



## ES05

Brandeggiabile in acciaio da 2 kg. a polvere  
Doppia staffa metallica di fissaggio,  
Conforme normativa europea EN3.  
Conforme FIA

*2 kg hand-held steel bottle.*

*Double steel bracket.*

*In compliance with EN3 and FIA standard.*



## ES04

Impianto di estinzione meccanico  
in acciaio da 4,25l.

Adatto per vetture berline.

Composta da:

Staffe inox e fascette per il montaggio.

2 rotoli di tubo in alluminio 6x8 mm,  
lunghezza 4 metri.

Tiranti a cavetto esterno e tirante  
a cavetto interno.

4 raccordi con attacchi rapidi a T.

2 raccordi terminali ad L.

1 raccordo a tre vie.

6 ugelli polverizzatori.

2 adesivi circolari di identificazione.

*4,25 litres steel mechanical  
fire extinguisher system.*

*Suitable for saloon cars.*

*Composed by:*

*Assembly stainless steel brackets  
and bands.*

*2 4-m length 6x8-mm diameter  
aluminium rolls.*

*Internal and external cable tie rods.*

*4 T-quick disconnect attachments.*

*2 terminal L-attachments.*

*1 three-way connection.*

*6 spray nozzles.*

*2 round identification adhesives.*



## E503

Impianto estinzione elettrico con bombola in alluminio 4,25 l. Adatto per vetture berline.

Composto da:

- staffe inox e fascette per il montaggio,
- 2 rotoli di tubo in alluminio 6x8 mm, lunghezza 4 metri,
- centralina di comando,
- pulsante di attivazione esterna,
- filì e connessione per il cablaggio,
- guaina ignifuga,
- 4 raccordi con attacchi rapidi a T,
- 2 raccordi terminali ad L,
- 1 raccordo a tre vie,
- 6 ugelli polverizzatori,
- 2 adesivi circolari di identificazione.

*Electrical fire extinguisher system with 4,25 litres aluminium bottle.*

*Composed by:*

- assembly stainless steel brackets and band,*
- 2 4-m length 6x8-mm diameter aluminium rolls,*
- Central control box,*
- External activation control,*
- Cable connections and wiring,*
- Fire resistant sheath,*
- 4 T-quick disconnect attachments,*
- 2 terminal L-attachments,*
- 1 three-way connection,*
- 6 spray nozzles,*
- 2 round identification adhesives.*



## E508

Impianto estinzione elettrico con bombola in acciaio 4,25 l.

Adatto per vetture berline.

Composto da:

- staffe inox e fascette per il montaggio,
- 2 rotoli di tubo in alluminio 6x8 mm, lunghezza 4 metri,
- centralina di comando
- pulsante di attivazione esterna
- filì e connessione per il cablaggio,
- guaina ignifuga,
- 4 raccordi con attacchi rapidi a T,
- 2 raccordi terminali ad L,
- 1 raccordo a tre vie,
- 6 ugelli polverizzatori,
- 2 adesivi circolari di identificazione.

*Electrical fire extinguisher system with 4,25-litre Stainless steel bottle.*

*Composed by:*

- assembly stainless steel brackets and band,*
- 2 4-m length 6x8-mm diameter aluminium rolls,*
- central control box,*
- external activation control,*
- aluminium rolls,*
- cable connections and wiring,*
- fire resistant sheath,*
- 4 T-quick disconnect attachments,*
- 2 terminal L-attachments,*
- 1 three-way connection,*
- 6 spray nozzles,*
- 2 round identification adhesives.*



## ES09

Impianto estinzione meccanico con bombola in acciaio 2,8 l. Adatto per vetture monoposto. Composto da: staffe inox e fascette per il montaggio, 2 rotoli di tubo in alluminio 6x8 mm, lunghezza 4 metri, tiranti a cavetto esterno e tirante a cavetto interno, 3 raccordi con attacchi rapidi a T, 2 raccordi terminali ad L, 1 raccordo a 3 vie, 5 ugelli polverizzatori, 2 adesivi circolari di identificazione.

*Mechanical fire extinguisher system with 2.8 litres stainless steel bottle. Suitable for single seater car. Composed by: assembly stainless steel brackets and band, 2 4-m length 6x8-mm diameter aluminium rolls, internal and external cable tie rods, 3 T-quick disconnect attachments, 2 terminal L-attachments, 1 three-way connection, 5 spray nozzles, 2 round identification adhesives.*



## ES10

Impianto estinzione elettrico con bombola in alluminio 2,8 l. Adatto per vetture monoposto. Composto da: staffe inox e fascette per il montaggio, 2 rotoli di tubo in alluminio 6x8 mm, lunghezza 4 metri, centralina di comando, pulsante di attivazione esterna, fili e connessione per il cablaggio, guaina ignifuga, 3 raccordi con attacchi rapidi a T, 2 raccordi terminali ad L, 1 raccordo a tre vie, 5 ugelli polverizzatori, 2 adesivi circolari di identificazione.

*Electrical fire extinguisher system with 2.8 litres stainless steel bottle. Suitable for single seater car. Composed by: assembly stainless steel brackets and band, 2 4-m length 6x8-mm diameter aluminium rolls, central control box, external activation control, cable connections and wiring, fire resistant sheath, 3 T-quick disconnect attachments, 2 terminal L-attachments, 1 three-way connection, 5 spray nozzles, 2 round identification adhesives.*



# PEDANE FOOTRESTS

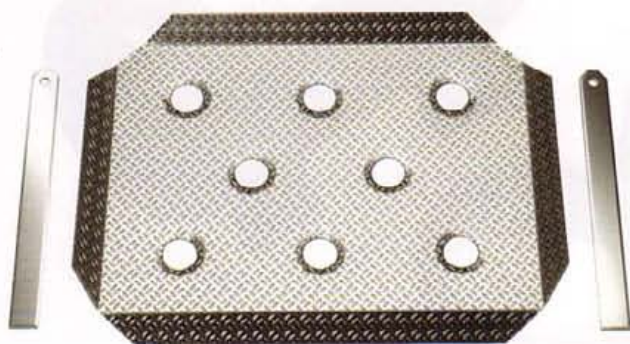

**Z170460** BIANCO/WHITE

Pedana navigatore collassabile.  
Alluminio mandorlato anodizzato.

*Co-driver footrest collapsible.  
Anodised aluminium.*



**Z170360** BIANCO/WHITE

Pedana pilota.  
Alluminio mandorlato anodizzato.  
Completa di accessori per il montaggio.

*Anodised aluminium.  
Driver footrest.  
Mounting accessories included.*

# PEDALIERE PEDALS



**Z170160** SILVER/SILVER

Set 3 pezzi.  
Alluminio mandorlato anodizzato.  
Completa di accessori per il montaggio.

*3 pcs. Set  
Anodised aluminium pedals  
Mounting accessories included*



**Z170140**  
ROSSO/RED



**Z170110**  
BLU/BLUE



**Z170180**  
ORO/GOLD



**Z280995** RETE PORTACASCHI  
HELMET NET

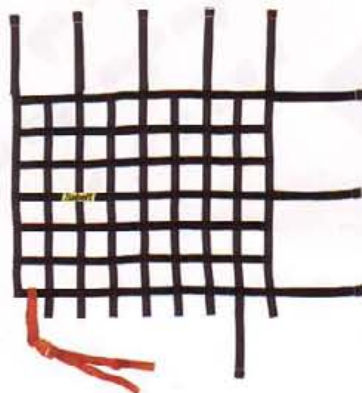

**RETE FINESTRINO WINDOW NET**

**Z280985** NERO/BLACK

Conforme FIA.

*FIA approved.*



**Z500009 LASTRA CARBONIO  
CARBON PLATE**

Dimensioni: 300 x 300 x 2 mm.

Measures: 300 x 300 x 2 mm.



**LASTRA PARASPRUZZI  
MUD FLAPS**

**Z280840** ROSSO/RED  
**Z280830** BLU/BLUE  
**Z280880** GIALLO/YELLOW

Dimensioni: mm 300 x 52 x 0,3

Measures: mm 300 x 52 x 0,3



**PARASPRUZZI SAGOMATO  
SHADED MUD FLAP**

**Z280950** BIANCO/WHITE  
**Z280940** ROSSO/RED

Dimensioni: mm 520 x 300 x 0,3

Measures: mm 520 x 300 x 0,3



**Z240450 CAVO COMANDO  
CONTROL CABLE**



**Z240300 STACCABATTERIA BIPOLARE  
BIPOLAR BATTERY  
DISCONNECTOR**

Non omologato FIA.  
Consente di interrompere il sottocircuito elettrico principale.  
Montaggio previsto su impianti 6/12/24.

*Non FIA approved  
Allows main electrical sub-circuit interruption  
To be mounted on 6/12/24 equipments.*



**Z240400 STACCABATTERIA ESAPOLARE  
6-POLE BATTERY  
DISCONNECTOR**

Conforme FIA.  
Consente di interrompere tutti i circuiti elettrici  
e di arrestare il motore.  
Montaggio previsto su impianti 6/12/24.

*FIA approved  
Allows all electrical circuits interruption and stops engine  
To be mounted on 6/12/24 equipments.*



**GANCI COFANO  
BONNET PINS**

**Z400130** BLU/BLUE  
**Z400140** ROSSO/RED  
**Z400199/S** ALLUMINIO/ALUMINIUM



**GANCI COFANO A MOLLA  
SPRING BOTTENT PINS**

**Z240200**

**ATO1 FISSAGGIO RUOTA  
DI SCORTA  
SPARE WHEEL SUPPORT**



**ATO2 FISSAGGIO RUOTA  
DI SCORTA A CRICCHETTO  
SPARE WHEEL RATCHET**

Fornito con ganci e piastre di fissaggio  
*Supplied with hooks and plates*

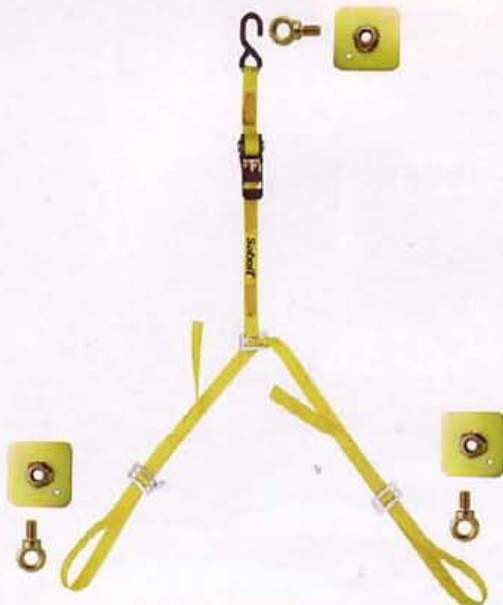

## INDICE INDEX

- p. 116 **TUTE CIK-FIA**  
*CIK-FIA SUITS*
- p. 121 **SCARPE-GUANTI-SOTTOTUTA**  
*SHOES-GLOVES-UNDERWEAR*
- p. 124 **KART PER BAMBINO**  
*KART KID*
- p. 124 **TUTE BAMBINO**  
*KID SUITS*
- p. 125 **SCARPE BAMBINO**  
*KID SHOES*
- p. 125 **GUANTI BAMBINO**  
*KID GLOVES*
- p. 126 **ACCESSORI KART**  
*KART ACCESSORIES*
- p. 128 **TUTA ANTIPIOGGIA**  
*RAIN SUIT*
- p. 129 **FILTRO KART**  
*AIR INTAKE SILENCER*



# TUTA FUTUR LOOK

## FUTUR LOOK SUIT

Dalla comprensione dell'estrema importanza di versatilità e fantasia nel mondo del kart dominato dai giovani piloti nasce la nuova Future Look.

Grazie alla rivoluzionaria tecnica di sublimazione del tessuto, Sabelt è in grado di trasferire una qualsiasi immagine in vettoriale sulla stoffa con cui vengono confezionate le tute kart eliminando in questo modo gli inconvenienti quali spessore e non traspirabilità tipici del ricamo.

Modello base "Champion".

*Starting from the consciousness of the importance of fantasy and look versatility in kart where young boys are dominating, comes out the new Future Look suit.*

*Thanks to revolutionary technique of fabric sublimation, Sabelt is able to reproduce any image on suit fabric avoiding typical drawbacks of embroidering such as thickness and no perspiration.*

*Base model: "Champion".*

### ESEMPIO DI PERSONALIZZAZIONE CUSTOMIZED EXAMPLE



# TUTA CHAMPION DESIGN

## CHAMPION DESIGN SUIT

**BICOLORE TWO-COLOURED**

**KFTU0041** ROSSO-BIANCO/RED-WHITE

Nuovo design creato da Sabelt sulla base della tuta Champion.  
Tuta composta da tre strati. Maniche flottanti.  
Livello II. Taglie: 46-64

*New Sabelt Design based on the Champion suit model.  
Three layers. Floating sleeves.  
Level II. Size 46-64*



**KFTU0014**  
BLU NAVI-BIANCO/NAVY BLUE-WHITE



# TUTA CHAMPION DUO

## CHAMPION DUO SUIT

**BICOLORE TWO-COLOURED**

**KFTU4101** BIANCO/BLU/WHITE-BLUE

Top della gamma Sabelt.

Tre strati: tessuto esterno a costine lucido; strati interni in spugna.  
Cucitura laterale sulle braccia, giromanica flottante in maglina,  
tasca interna.

Omologazione: livello II, tuta utilizzabile in tutti i campionati.  
Taglie disponibili: da 46 a 64.

*The top of the Sabelt range.*

*Three layers: external shiny fabric; internal towelling layers.*

*Side seams on the arms, floating sleeves, inside pockets.*

*Homologation: level II, usefull in every championship.*

*Sizes: 46 to 64.*



Giro manica in maglina.  
*Floating sleeves.*



**KFTU5001**  
GRIGIO-ROSSO/GREY-RED



**KFTU5201**  
GRIGIO-NERO/GREY-BLACK

# TUTA CHAMPION

## CHAMPION SUIT

### **KFTU0001** ROSSO/RED

Versione monocolore della tuta top di gamma.  
Tre strati: tessuto esterno a costine lucido; strati interni in spugna.  
Giromanica flottante in maglina, tasca interna.  
Omologazione: livello II, tuta utilizzabile in tutti i campionati.  
Taglie disponibili: da 46 a 64.

*One-colour version of Sabelt top suit.  
Three layers: external shiny fabric; inner towelling layers.  
Floating sleeves, inside pockets.  
Homologation: level II, suit useful in every championship.  
Sizes: 46 to 64.*



**KFTU5501** GRIGIO  
GREY



**KFTU1101** BLU  
BLUE



**KFTU2201** NERO  
BLACK

# TUTA ECO KART2

## ECO KART2 SUIT

### **KFTU2202L2** NERO/BLACK

Versione economica della gamma.

Tuta composta da tre strati: tessuto esterno lucido accoppiato ad un doppio strato di spugna. Perfetta traspirabilità e ottima vestibilità.

Omologazione: livello 2, utilizzabile in tutti i campionati.

Taglie: da XS a XXL.

*Economic version of Sabelft suit range.*

*Three layers: external shiny fabric paired up with two towelling layers.*

*Excellent persiration and wearability.*

*Homologation: level II, suit useful in every championship.*

*Sizes: from XS to XXL.*



**KFTU0002L2**  
ROSSO/RED

**KFTU1102L2**  
BLU/BLUE

# SCARPE KART

## KART SHOES

### STREET KART

#### K131140 ROSSO/RED

Versione dedicata al kart della scarpa street.  
 Scarpa con tomaia in camoscio e inserti in pelle bianca.  
 Chiusura con velcro per una calzata più sicura.  
 Speciale design sulla caviglia per una migliore mobilità del piede.  
 Suola in gomma antiscivolo con design speciale digit.  
 Estremamente leggera.  
 Taglie dalla 36 to 48.

*Street shoes dedicated to kart.  
 Suede mid boots with white leather inserts.  
 Ankle velcro fastening for secure fit.  
 Special heel design to enable the foot to pivot.  
 Non-slip rubber sole with Digit grip.  
 Lightweight.  
 Sizes from 36 to 48.*

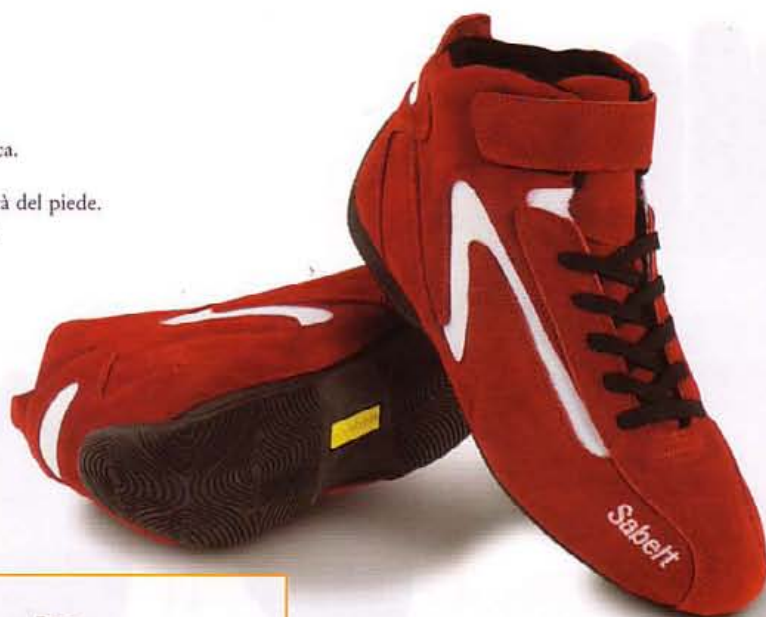

K131110 BLU/BLUE



K131120 NERO/BLACK



### TOP KART

#### K131320 NERO/BLACK

Nuova scarpa kart realizzata in pelle scamosciata. Interno tomaia realizzato in materiale traforato traspirante.  
 Rinforzo esterno in pelle. Suola digit: resistente e leggera garantisce massima sensibilità sul pedale.  
 Taglie dalla 36 to 48.

*New karting shoes in suede.  
 Internal breathable material, external reinforcement in leather.  
 Non-slip rubber sole with Digit grip: Light and resistant guarantees maximum sensibility on the pedal.  
 Sizes from 36 to 48.*



K131340 ROSSO/RED



K131330 BLU ROYAL/ROYAL BLUE

# GUANTI GLOVES



## ECOKART

- KFGT0002** ROSSO/RED
- KFGT1002** BLU/BLUE
- KFGT2002** NERO/BLACK

Palmo in pelle scamosciata imbottito.  
Chiusura con velcro sul polso.  
Taglia: 7 a 12.

*Stuffed palm in suede.*  
*Velcro wrist closure.*  
*Sizes: 7 to 12.*



## KART LUX

- KFGT0020** NERO/BLACK
- KFGT0030** BLU/BLUE
- KFGT0040** ROSSO/RED

Guanto realizzato con materiale elastico.  
Resistente e confortevole.  
Rinforzi sul palmo in pelle scamosciata  
imbottiti  
Taglie: da 7 a 13.

*Glove made of elastic material.*  
*Resistant and comfortable.*  
*Suede reinforcement on palm*  
*Sizes: 7 to 13.*

# SOTTOTUTA UNDERWEAR



## T-SHIRT

**KFSO6001** BIANCO/WHITE

In coolmax. Taglie: da S a XL. *In coolmax. Sizes: S to XL.*



## SOTTO CASCO BALACLAVA

**KFSO0004** ROSSO/RED  
**KFSO1004** BLU/BUE

Apertura normale. 100% cotone. Taglia unica.

*Open face. 100% cotton. One size.*



## SOTTO CASCO BALACLAVA

**KFSO4004C** BIANCO/WHITE

Apertura normale. In coolmax. Taglia unica.

*Open face. In coolmax. One size.*



## CALZE LUNGHE IN COOLMAX LONG SOCKS IN COOLMAX

**KFSO5001** BIANCO/WHITE

Taglie: da S a XL.

*Sizes: S to XL.*



## MAGLIA MANICHE LUNGHE LONG SLEEVES TOP

**KFSO0001** ROSSO/RED  
**KFSO1001** BLU/BUE

Maglia maniche lunghe, collo lupetto,  
100% cotone. Taglie da S a XL.

*Roll neck long sleeves t-shirt,  
100% cotton. Sizes from S to XL.*

## MAGLIA MANICHE LUNGHE LONG SLEEVES TOP

**KFSO4002C** BIANCO/WHITE

Maglia maniche lunghe, collo lupetto,  
coolmax. Taglie da S a XL.

*Roll neck long sleeves t-shirt, coolmax.  
Sizes from S to XL.*

# TUTE KART KID

## KART KID SUITS



### CHAMPION DUO

**KFTU5201**  
GRIGIO-NERO / GREY-BLACK

Taglie: dalla 28 all 44.

Sizes: from 28 to 44.

**ECO KART2 - KFTU0002L2** ROSSO / RED  
**ECO KART2 - KFTU2202L2** NERO / BLACK

Taglie: dalla 1 alla 4 Sizes: from 1 to 4



**CHAMPION - KFTU1101** BLU / BLUE



# SCARPE KART KID

## KART KID SHOES

### K131342 ROSSO-NERO/RED-BLACK

Scarpa mid dedicata ai bambini. Tomaia in camoscio.  
Chiusura con velcro per una calzata più sicura.  
Suola pilot in mescola sintetica TR.  
Misure dalla 30 alla 34.

*Mid shoes dedicated to kids. Suede vamp.  
Velcro fastening for secure fit.  
Pilot design sole in TR syntetic mixture.  
Sizes from 30 to 34.*



K131312 BLU-NERO  
BLUE-BLACK



K131320 NERO/BLACK



# GUANTI KART KID

## KART KID GLOVES



### KART BAMBINO KART KID

**KFGT0003** ROSSO/RED  
**KFGT1003** BLU/BLUE  
**KFGT2003** NERO/BLACK

Palmo in pelle liscia bianca,  
chiusura con velcro sul polso.  
Taglie: 1 a 6.

*White leather palm.  
Velcro wrist fastening.  
Sizes: 1 to 6.*

# ACCESSORI KART KART ACCESSORIES

## COLLARE ANATOMICO ANATOMIC COLLAR

KFAC0002



## COLLARE STANDARD STANDARD COLLAR

KFAC0001



## CORPETTO PROFESSIONALE PROFESSIONAL WAISTCOAT

KFCO0002

Corpetto prodotto con materiali compositi,  
nuova tecnologia di sicurezza.  
Taglie: 1, 2, 3.

*Professional waistcoat by freemind  
Rib protection waistcoat made with composite  
materials, new safety technology.  
Sizes: 1, 2, 3.*

## CORPETTO STANDARD STANDARD WAISTCOAT

KFCO0001

Taglie da XS a XL.

*Sizes: from XS to XL.*





**COPRI KART  
KART COVER**

**KFAC0006** NERO/BLACK



**VENTOLA ANTIPIOGGIA  
TURBO VISOR**

**KFAC0004**



**MANOMETRO 4 BAR GLICERINA  
MANOMETER 4 BAR GLYCERIN**

**KFAC0005**

**BORSA PORTA CASCO  
HELMET BAG**

**RFBS0005**



**BORSA PORTA RUOTE  
TYRES BAG**

**KFAC0010**

# TUTA ANTIPIOGGIA RAIN SUIT

**KFTU0003**

Prodotta in materiale lattice.  
Taglie: da XS a XXL.

*Made with latex material.  
Sizes: from XS to XXL.*



Tasca. Pocket.

# FILTRO KART

## AIR INTAKE SILENCER

### SABKART KFFT0001

Nuovo filtro kart conforme alla normativa 2004 Cik N° 47-48/SA09, sviluppato in collaborazione con Oral Engineering, partner nello sviluppo dei motori Toyota e BMW F1.

Modello universale per tutte le categorie: 100 cc, 125 cc, 250 cc 4 tempi.

Composto da un corpo in plastica completo di un elemento filtrante a 4 strati di cotone completamente lavabile in quanto rivestito da una rete in alluminio.

Viene fornito con doppio kit di condotti d'aspirazione (diametro 23 e 30 mm).

Assicura una migliore resa del motore.

*A new kart filter keeping with 2004 Cik provisions n. 47-48/SA09, developed in collaboration with Oral Engineering.*

*Universal model for all categories:*

*100cc, 125cc, 255cc 4 times.*

*Is composed of a composite material box with a 4 cotton layers filter element inside.*

*Washable because of his aluminium net cover.*

*This filter is supplied with suckers (diameter 23 and 30 mm).*

*Guarantee a better engine performance.*

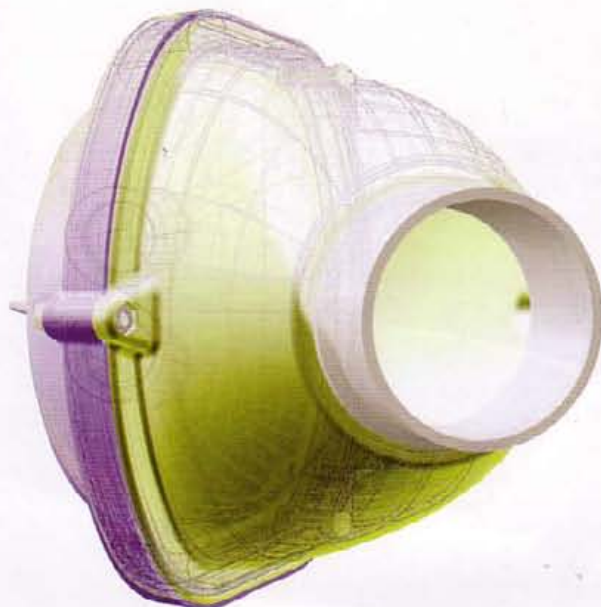

## INDICE INDEX

- p. 132 **SEDILI PELLE**  
*LEATHER SEATS*
- p. 134 **SEDILI IN TESSUTO**  
*FABRIC SEATS*
- p. 138 **BASI UNIVERSALI**  
*UNIVERSAL SEATS FRAMES*
- p. 139 **VOLANTI**  
*STEERING WHEELS*
- p. 140 **ACCESSORI ABITACOLO**  
*INTERIOR ACCESSORIES*



# SEDILE EURO EURO SEAT



## L101270 BEIGE/BEIGE

Sedile con sistema di ribaltamento integrato nella struttura e microregolazione dell'inclinazione schienale. Completo di base sedile con vaschetta metallica e sistema integrato anti-affossamento. Robusto telaio realizzato in lamiera di acciaio con montanti stampati. Imbottiture in schiuma iniettata. Rivestimento in pelle. Non omologato.

*Integrated folding system and backrest inclination adjustment.  
Seat base with metal tank included and integrated anti-sheaving system.  
Steel plate loom, printed stud. Leather covered.  
Injected foam.  
Non homologated.*

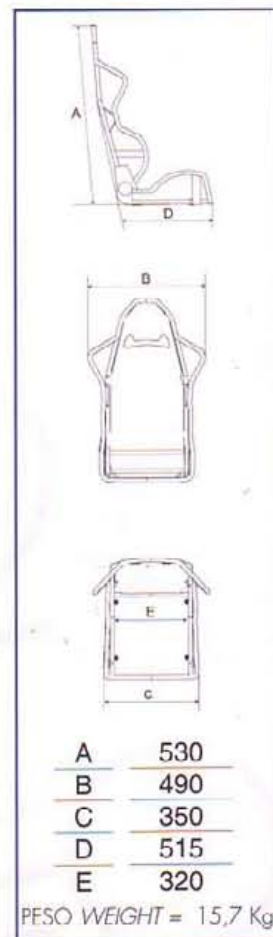

**L101250**  
GRIGIO CHIARO/LIGHT GREY



**L101220**  
NERO/BLACK



**L101244**  
ROSSO/RED

# SUPPORTI SEDILI SEATS DISPLAYS

Al momento dell'ordine specificare il sedile per cui necessita il supporto in quanto vi sono differenze nei fissaggi.

*When ordering, please specify for which seat you need the support, as the fixing holes are not all the same.*



## Z200070R/A Adapter

Supporto 5 ruote per poltrone da ufficio, adattatore incluso  
*5-wheels display for office chair, adapte included.*



## Z200061

Supporto in acciaio, verniciatura nera.  
*Steel display, black painted.*



## Z200070V

Supporto in acciaio, verniciatura argento.  
*Steel display, silver painted.*



## Z200070P

Supporto in plexiglass.  
*Plexiglass display.*

# SEDILE EURO EURO SEAT

## Z101224 ROSSO-NERO / RED-BLACK

Versione in tessuto del sedile Euro.  
Sistema di ribaltamento integrato  
nella struttura e microregolazione  
dell'inclinazione schienale.  
Completo di base sedile con vaschetta metallica  
e sistema integrato anti-affossamento.  
Robusto telaio realizzato in lamiera di acciaio  
con montanti stampati.  
Imbottitura in schiuma iniettata.  
Non omologato.

*Fabric version of Euro seat.  
Folding system integrated  
and backrest inclination adjustment.  
Seat base with metal tank included  
Anti-shelving system integrated.  
Steel plate loom, printed stud. Injected foam.  
Non homologated.*

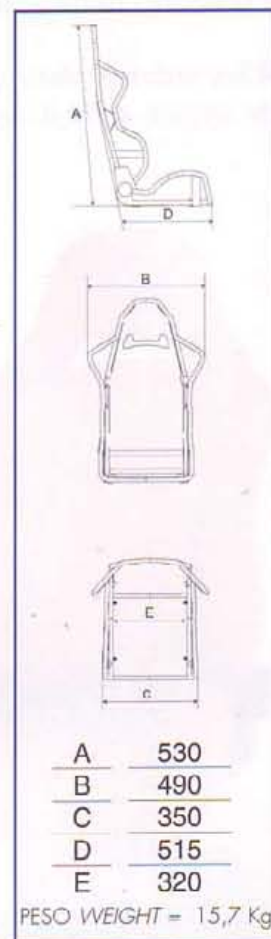

**Z101225** GRIGIO-NERO  
GREY-BLACK



**Z101250** GRIGIO / GREY



**Z101223** BLU-NERO  
BLUE-BLACK



**Z101220** NERO  
BLACK

# SEDILE GT2 TUNING GT2 TUNING SEAT



## RFSE2012 NERO/BLACK

Scocca in fibra di vetro finitura gel-coat.  
5 fori passacintura.  
Cuscino standard rimovibile.  
Fianchetti seduta ribassati.  
Fissaggio con attacchi laterali.  
Non omologato.

*Gel-coated fibreglass shell.  
5 harness slots.  
Removable standard leg cushion.  
Lower side support.  
Side mounting.  
Non homologated.*

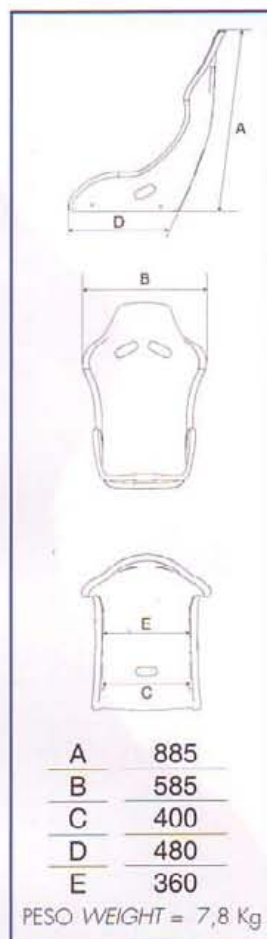

**RFSE0012**  
ROSSO/RED



**RFSE1012**  
BLU ROYAL/ROYAL BLUE



**RFSE5012**  
BLU NAVY/NAVY BLUE

# SEDILE GT1 TUNING GT1 TUNING SEAT



## RFSE0011 ROSSO/RED

Scocca in fibra di vetro rivestito completamente in tessuto.  
Poggiareni integrato.  
Cuscino standard rimovibile.  
5 fori passacintura.  
Fissaggio con attacchi laterali.  
Non omologato.

*Fibreglass shell, back side upholstered.  
Lumbar support integrated.  
Removable standard leg cushion.  
5 harness slots.  
Side mount.  
Non homologated.*

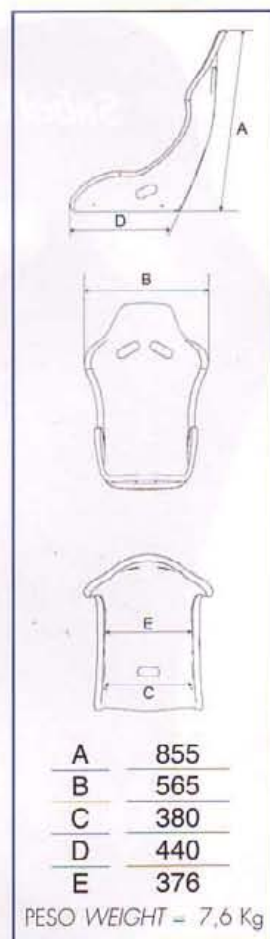

**RFSE1011**  
BLU ROYAL/ROYAL BLUE



**RFSE5011**  
GRIGIO/GREY



**RFSE2011**  
NERO/BLACK

# SEDILE STREET RACER STREET RACER SEAT



**RFSE0210** ROSSO-NERO/RED-BLACK

Struttura tubolare in acciaio totalmente rivestito in tessuto.  
Cuscino standard rimovibile.  
5 fori passacintura.  
Doppi attacchi: laterali e inferiori.  
Non omologato.

*Fabric covered tubular steel frame.  
Removable standard leg cushion.  
5 harness slots.  
Both side and bottom mount.  
Non homologated.*



**RFSE3010** BLU ROYAL  
ROYAL BLUE



**RFSE0010** ROSSO/RED

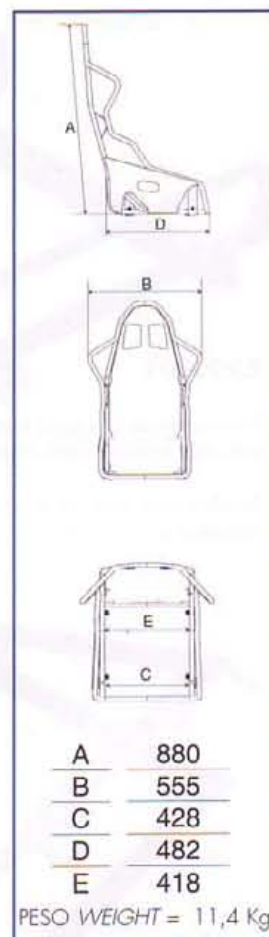

**RFSE1210** BLU-NERO  
BLUE-BLACK



**RFSE1310** BLU-BLU ROYAL  
BLUE-ROYAL BLUE



**RFSE2010** NERO/BLACK



**RFSE5010** GRIGIO  
GREY

# MODELLI UNIVERSALI

## UNIVERSAL MODEL



### Z200001

Base universale con kit di regolazione verticale - Interasse fino a 430 mm.

*Standard frame with vertical adjustment kit. Wheelbase up to 430 mm.*

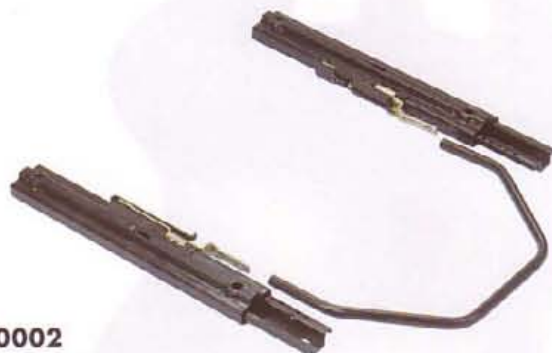

### Z200002

Guide scorrevoli.

*Runner guide frame.*



### Z200044

Base universale con dispositivo di ribaltamento.

*Standard frame with flip-up device.*

## Istruzioni per il montaggio

## Seat mounting instructions



Guida scorrevole originale o specifica (Z200002) secondo le vetture (vedere lista applicazioni).  
*Original or specific runner guide (Z200002) according to vehicle model (see application list).*



Sistema di ribaltamento (Z200044). Si fissa tra la base e la guida scorrevole.  
*Flip-up system (Z200044). Mounts between seat frame and runner guide.*



Base universale o specifica in funzione della vettura (vedere lista applicazioni).  
Si fissa tra il pianale e il sistema di ribaltamento (Z200044).  
*Standard or specific seat frame according to vehicle model (see application list). Mounts between floor and flip-up system (Z200044).*

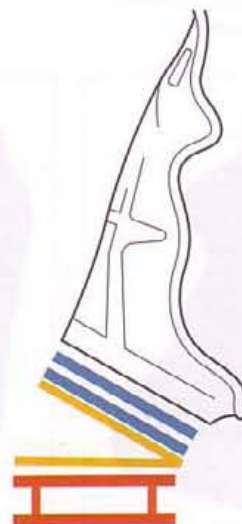

# VOLANTI STEERING WHEELS



## TORQUE

- RFVO0012X** ROSSO/RED
- RFVO1012X** BLU/BLUE
- RFVO2012X** NERO/BLACK

Volante piatto diametro 330 mm.  
impugnatura ellittica in poliuretano.

*Flat 330 mm diameter steering wheel.  
elliptical section polyurethane grip.*



## PHANTOM

- RFVO2013** NERO/BLACK
- RFVO0013** ROSSO/RED

Volante piatto diametro 330 mm.  
impugnatura ellittica in pelle traforata nera e Alcantara®.

*Flat 330 mm diameter steering wheel.  
elliptical section, punched black leather and Alcantara®.*



# GHIERE CENTRAL RINGS

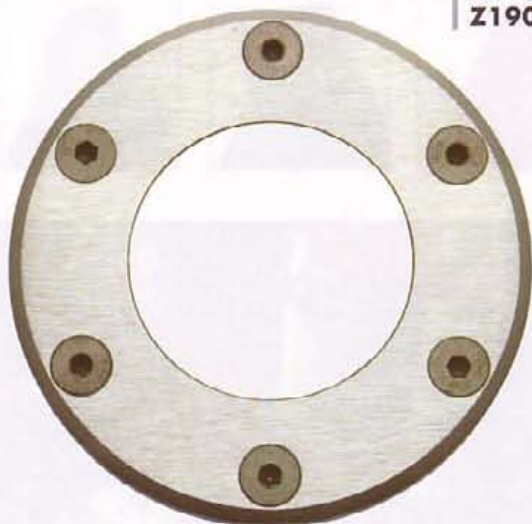

- Z190120** NERO/BLACK
- Z190155** ALLUMINIO/ALUMINIUM
- Z190199** CARBONIO/CARBON LOOK
- Z190130** BLU/BLUE
- Z190140** ROSSO/RED



# COPRI FRENO A MANO HANDLE BRAKE COVER



- RFFM2001** NERO/BLACK
- RFFM5001** GRIGIO CHIARO/LIGHT GRAY
- RFFM9001** CUIO/LEATHER
- RFFM0001** ROSSO/RED
- RFFM1001** BLU/BLE

Semplice da applicare.  
In pregiata pelle con inserti in alluminio.

*Easy to mount.  
Smooth leather with aluminium insert.*



# COPRI CAMBIO GEAR LEVER COVER



- RFCU2001** NERO/BLACK
- RFCU5001** GRIGIO CHIARO/LIGHT GREY
- RFCU9001** CUIO/LEATHER
- RFCU0001** ROSSO/RED
- RFCU1001** BLU/BLE

In pelle.

*Smooth leather.*



# POMELLI

## GEAR KNOB



### POMELLO SFERA GEAR KNOB SFERA

**RFPC0003** ROSSO/RED  
**RFPC1003** BLU/BLUE  
**RFPC2003** NERO/BLACK

Pomello in pelle.

*Smooth leather gear knob.*



### POMELLO SFERA + GEAR KNOB SFERA +

**RFPC0004** ROSSO/RED  
**RFPC1004** BLU/BLUE  
**RFPC2004** NERO/BLACK

Pomello in pelle, versione per auto con cambio a siringa.

*Smooth leather gear knob for cars with a lift up collar for reverse gear selection.*

# PEDALIERE

## PEDALS



### Z170560 ARGENTO/SILVER

Design innovativo per la pedaliera in alluminio con inserti antiscivolo.  
 Di facile montaggio.

*New design.  
 Aluminium pedal with grip material inserts.  
 Easy mounting.*

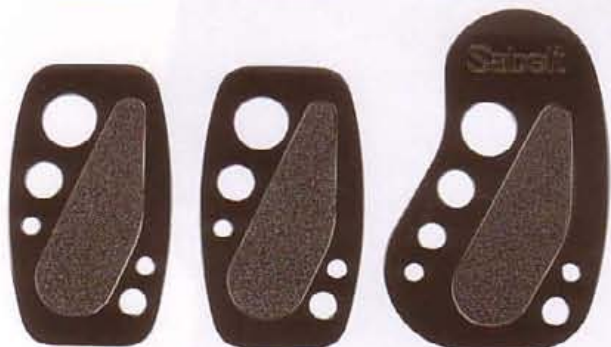

### Z170520 NERO/BLACK

Design innovativo per la pedaliera in alluminio con inserti antiscivolo.  
 Di facile montaggio.

*New design.  
 Aluminium pedal with grip material inserts.  
 Easy mounting.*

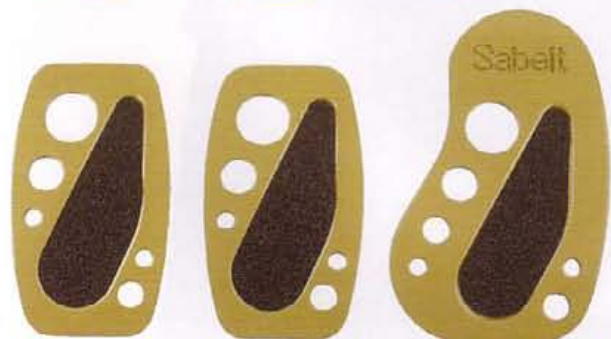

### Z170580 GIALLO ORO/GOLD

Design innovativo per la pedaliera in alluminio con inserti antiscivolo.  
 Di facile montaggio.

*New design.  
 Aluminium pedal with grip material inserts.  
 Easy mounting.*

# SPORTSWEAR SPORTSWEAR

## INDICE INDEX

p. 144 **ABBIGLIAMENTO SPORTIVO**  
**SPORTSWEAR**

p. 151 **SCARPE**  
**SHOES**

p. 152 **BORSE**  
**BAGS**

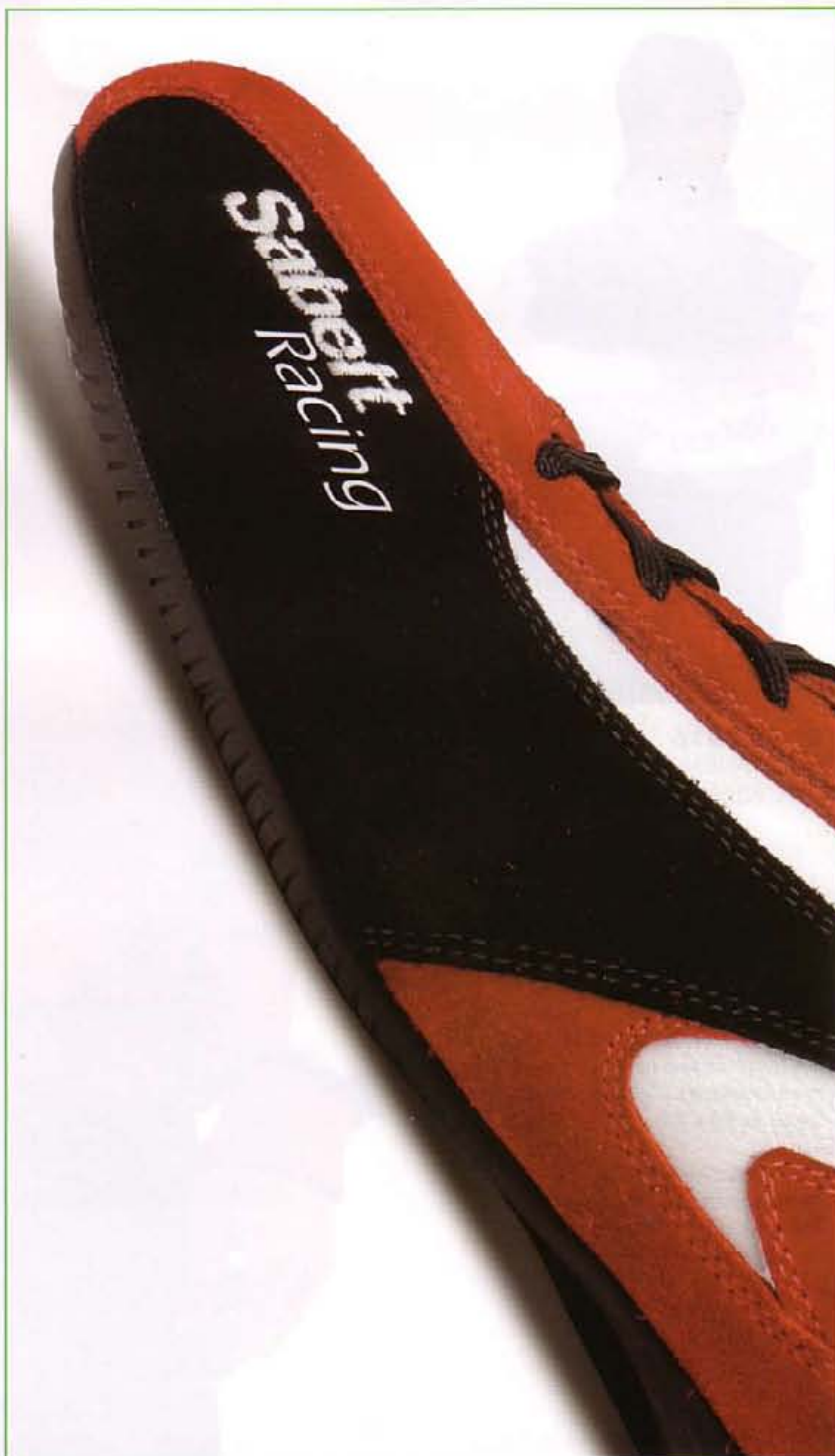

# GIACCA SABELT

## SABELT JACKET



**Z60GISAB16**  
BLU ROYAL-BIANCO  
ROYAL BLUE-WHITE

**Z60GISAB46**  
ROSSO-BIANCO/RED-WHITE

Giacca invernale, modello bomber.  
Realizzata sulla base del nuovo design Sabelt.  
Tessuto nylon trattato: alta traspirabilità e  
buona resistenza alla colonna d'acqua.  
Taglie: da XS a XXL.

*Winter jacket, bomber model.  
Produced on the new Sabelt design look.  
Treated nylon fabric: high breathability  
and good resistance to water.  
Sizes: XS to XXL*



# FELPA SABELT

## SABELT SWEATSHIRT



**Z60FESA46** ROSSO-BIANCO/RED-WHITE



**Z60FESAB16**  
BLU ROYAL-BIANCO  
ROYAL BLUE-WHITE

Felpe Sabelt realizzata in tessuto 100% cotone smerigliato. Morbido e confortevole adatto ad ogni tipo di stagione. Taglie: da XS a XXL.

*New Sabelt sweatshirt made of 100% cotton.  
Soft and comfortable for every season.  
Sizes: XS to XXL.*

# GIACCA INVERNALE WINTER JACKET

## Z60GIT40 ROSSO/RED

Giacca invernale con 4 ampie tasche e coulisse interna.

100% poliestere,  
ottima impermeabilità.

Fodera interna in poliestere.

Gilet interno rimovibile con zip

in poliestere 100%,

imbottitura in ovatta

Taglie dalla S alla XL.

*Winter coat, top version.*

*4 loose-fitting pockets, internal coulisse.*

*100% polyester,*

*high Impermeability.*

*Inner lining in polyester.*

*Removable internal padded waist*

*coat with zip, 100% polyester,*

*internal padding*

*Sizes from S to XL.*



Z60GIT10 BLU NAVY/NAVY BLUE



Z60GIT20 NERO/BLACK

# FELPA SWEATSHIRT

## Z60FS40 ROSSO/RED

100% cotone,  
Zip sul collo  
Taglie da XS a XXL

100% cotton  
Short zipped  
Sizes from XS to XXL



Ricamo nuovo design Sabelt sulla schiena.  
*New Sabelt design embroidering on the back.*



## Z260FS10 BLU NAVY/NAVY BLUE



## Z260FS20 NERO/BLACK



# POLO

## POLO SHIRT

**Z60P40** ROSSO/RED

100% Cotone. Logo Sabelt ricamato.  
Taglie da XS a XXL.

*100% cotton. Sabelt Embroidery.  
Sizes from XS to XXL.*



**Z60P60** BIANCO/WHITE



**Z60P20** NERO/BLACK



**Z60P10** BLU NAVY/NAVY BLUE



# CAMICIA MANICA LUNGA

## LONG SLEEVES SHIRT

**Z60C460** BIANCO/WHITE

Camicia manica lunga di grande qualità.  
Taschino sul petto.  
Ricamo logo Sabelt.  
100% cotone.  
Taglie da S a XXL.

*Top quality long sleeve shirt.  
Features a breast pocket.  
Sabelt embroidery.  
Sizes from S to XXL.*



**Z60C430** AZZURRO/PALE BLUE



# CAMICIA MANICA CORTA

## SHORT SLEEVES SHIRT



**Z600CAM710**  
GIALLO-BLU / YELLOW-BLUE



**Z600CAM400**  
BIANCO-ROSSO / WHITE-RED



**Z600CAM410**  
BIANCO-BLU / WHITE-BLUE

Possibilità di avere la camicia team in due colori a vostra scelta. 100% cotone, taglie dalla S alla XXL. Contatta il nostro servizio clienti per maggiori informazioni.

*Possibility of the team shirt in two colours. 100% cotton, sizes from S to XXL. Please contact our Customer Service department for further information.*



**Z600CAM020**  
ROSSO-NERO / RED-BLACK

# CAPPELLINI

## FABRIC CAPS



**Z600020** NERO / BLACK  
**Z600040** ROSSO / RED  
**Z600080** GIALLO / YELLOW

Cappellino in cotone.  
Strong cotton fabric cap.

# PANTALONI TROUSERS

## PANTALONE LUNGO LONG TROUSERS

**Z60JOBP20** NERO/BLACK

Studiati per essere confortevoli, ideati per durare.  
100% cotone pesante. Tasche laterali porta utensili.  
Passa cintura porta radio. Tasche posteriori con chiusura velcro.  
Taglie da S a XXL.

*Styled for comfort, built to last.  
100% strong cotton twill. Two lateral tools pockets  
Radio holder on the belt. 2 back pockets with velcro fastening.  
Sizes from S to XXL*



## BERMUDA SHORTS Z60JOB20 NERO/BLACK

100% cotone pesante  
2 Tasconi laterali  
Tasche posteriori con chiusura velcro  
Taglie da S a XXL

*100% strong cotton twill,  
Two cargo pockets  
2 back pockets with velcro closure.  
Sizes from S to XXL*

## CINTURA SPORTSWEAR SPORTSWEAR BELT

**ZBELT10** BLU ROYAL/ROYAL BLUE  
**ZBELT40** ROSSO/RED  
**ZBELT20** NERO/BLACK

Cintura per pantaloni in nastro con fibbia in alluminio e apertura a sgancio rapido a rotazione.

*Belt for trousers in webbing with aluminium rotary quick release buckle.*



# SCARPE STREET LOW

## STREET LOW SHOES

### Z131740 ROSSO/RED

Design innovativo e grintoso, rispetto dello stile tipico del made in Italy anche per la versione bassa della scarpa street dedicata al tempo libero. Tomaia in pelle scamosciata, la suola è composta da una mescola leggera con lo speciale design "digit".  
Taglie dalla 36 to 48.

*Determined, innovative design, respect for typical Made in Italy style also for the low version of street model shoes dedicated to spare time.  
Reserched look perfectly match with improved comfort and practical use.  
Suede vamp, the sole is a light mixture material with a special digit design.  
Sizes from 36 to 48.*



Z131730 BLU/BLUE



Z131750 GRIGIO/GREY



Z131720 NERO/BLACK

# BORSE BAGS



## RFB50002 TRIP

Borsa viaggio di medie dimensioni.  
Provvista di numerose tasche  
e di un vano porta scarpe a tracolla.

*medium-sized trip bag, it has several pockets  
and shoes holder.  
Provided of shoulder belt.*

## RFB50004 ZIP

Pratico zainetto 20 litri.

*Practical rucksack, 20 l.*



## RFB50001 EASY

ROSSO/RED

Borsa viaggio di grandi dimensioni.  
Provvista di robuste ruote e maniglia retraibile  
per favorire il trasporto.

*Large-sized travel bag,  
Provided of strong wheels and retractable handle to  
favour carriage.*



## RFB50021 EASY

NERO/BLACK



## RFB50008 24H

Pratica e comoda borsa porta computer  
con tracolla.

*Handy and practical computer holder with  
shoulder belt.*

## Z60OMB24

Ombrello.

*Umbrella.*



**Sabelt**

Sabelt S.p.A.

via G. Rossa, 8/10/12 • 10024 Moncalieri (TO) Italia • Tel. +39.011.6477911 • Fax +39.011.6477999  
info@sabelt.com • www.sabelt.com